

The cover features a vibrant pink background with a large white, teardrop-shaped graphic element. Inside this white shape, the text 'Annual Report 2011' is written in a bold, pink, sans-serif font. Below the white shape, there are several thick, curved, overlapping bands in a rainbow color palette (red, orange, yellow, green, blue, purple).

Annual Report 2011

Railway Technical Research Institute
Japan



Hisashi TARUMI
President,
Railway Technical Research Institute

Foreword

After the Tohoku Region Pacific Coast Earthquake that hit Japan on March 11, 2011, the Railway Technical Research Institute (RTRI) made tremendous efforts as part of the operation to support, recover and restore the damaged railways in the area. In the meantime, while changing its legal status to become a public interest corporation on April 1, 2011, RTRI pushed ahead with various projects that had been assigned to it and succeeded in attaining almost all the targets that had previously been set for its research and development activities as a whole. In FY 2011, the second year in its FIVE-YEAR "RESEARCH 2010 program," RTRI intended to accelerate research and development for the future of railways, development of practical technologies and other basic research work.

For the project to establish test track simulation technology, a future-oriented subject requiring a particularly long research period, RTRI called upon the whole of its existing human resources and recruited new researchers, while being supported in parallel by other organizations; in this way it successfully carried out the related research and development projects as scheduled. Furthermore, RTRI established innovative measures to reinforce outdated structures as part of an effort to develop practical technologies and proposed a technique to issue early-stage earthquake warnings in the field of basic research. Despite the severe economic conditions, RTRI was fortunately able to contract with a number of other research and development organizations for various projects and it was able to apply the results to achieve a practical outcome.

On the other hand, the Railway Technology Promotion Center accepted valuable information and advice from a number of railway operators and from the members under its umbrella in order to fulfill its assigned mission. Given the importance of ensuring that technologies are handed down over generations, RTRI actively exchanged personnel with railway operators and accelerated its program to achieve

a younger age profile of its staff.

As in the past, RTRI also continued renewal and remodeling of existing research facilities, while effectively utilizing large-scale test equipment including a large vibration testing machine to simulate gigantic earthquake movements. The patents applied for registration this year amounted to 215 in number. The Railway International Standards Center, which was established the year before last, implemented an extensive information exchange process in Japan and abroad, while launching related committees with participation from members representing railway operators and manufacturers. RTRI contributed papers and extended support to the World Congress on Railway Research (WCRR) held in Lille, France, and deployed joint research programs with France, China, Korea and other countries, as part of its international activities.

A quarter century has passed since the privatization and division of Japanese National Railways. At this juncture, the presence of railways has come to be highly valued in different circles of society, whereas the severe circumstances affecting Japan are anticipated to last for some time into the future: these include the problems of energy supply, the unprecedentedly long span of human life and a low birth rate, along with the instability of the economy of the country affected by waves of globalization. Railways are no exception, in the sense that management is treading on thin ice in this grave situation. RTRI will make efforts, therefore, to contribute more to railway management through its research and development initiative. The contribution by the trustees, the lion's share in the operating funds of RTRI, which previously hovered at a low level, is now showing a tendency to rally. RTRI is required to integrate the wisdom and power of its researchers gifted with great talents, in order to develop railways further and subsequently accelerate the social and economic development of the country. In this context, RTRI trusts that it can count on readers continuing to extend their unchanged co-operation and support.

Contents

3	Organization
5	Medium and Long Term Master Plan – RESEARCH 2010 –
9	Statement of Activity Results 2011
29	International Activities
35	Newly Installed and Remodeled Machines/Facilities
37	Activities in the 25th Anniversary Year
39	Appendix

Organization

Organization

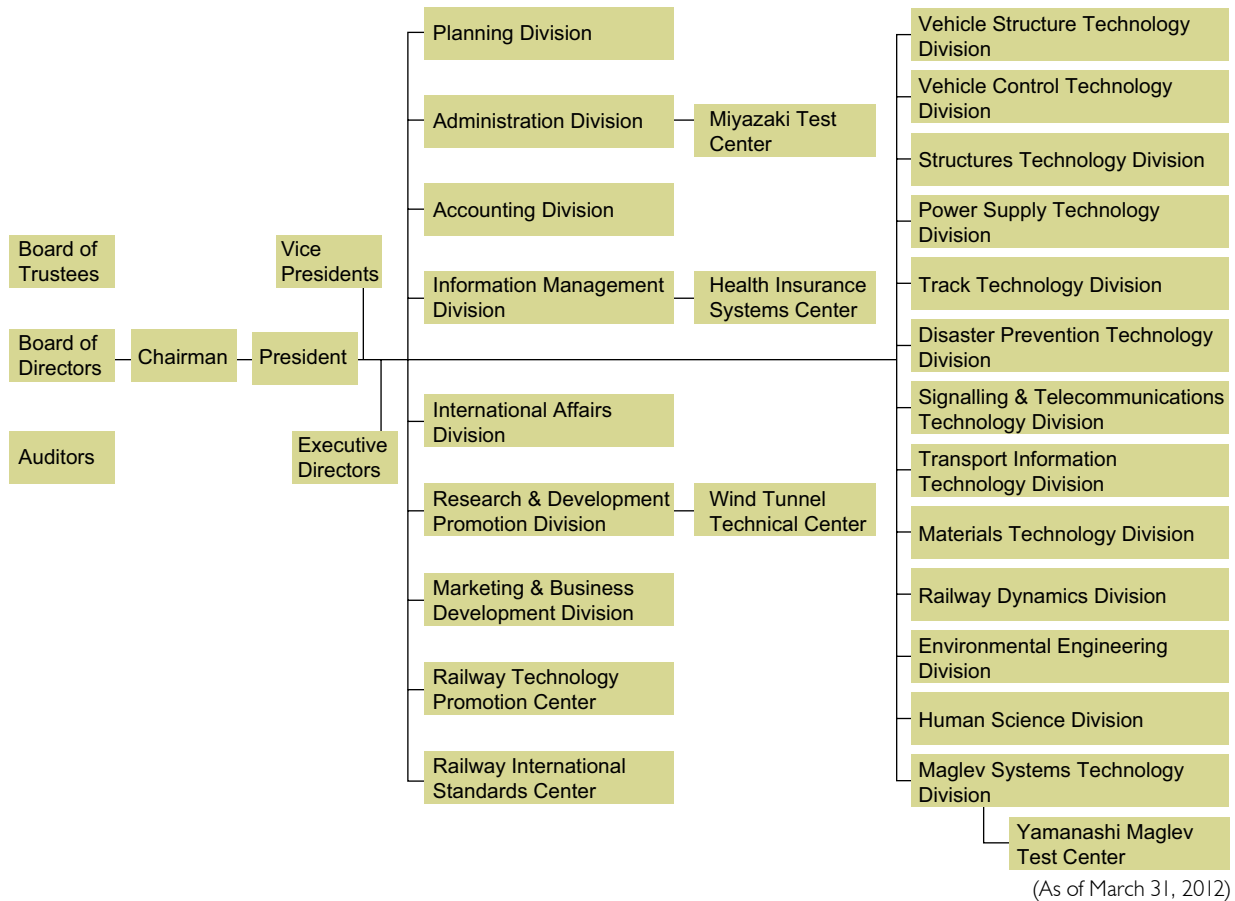

Board Members

Position	Name
Chairman	MASADA Eisuke
President	TARUMI Hisashi
Vice President	UCHIDA Masao
Vice President	KUMAGAI Norimichi
Executive Director	ICHIKAWA Atsushi
Executive Director	KAWAI Atsushi
Executive Director	SAWAI Kiyoshi
Executive Director	ICHIJO Masayuki
Executive Director	HAYASHI Yasuo
Executive Director	NAGATA Yutaka
Executive Director	YOSHIE Norihiko
Executive Director	NISHIMAKI Tsuguhiro
Executive Director	AOYAGI Toshihiko
Executive Director	HAYASE Touji
Executive Director	SUDA Yoshihiro
Executive Director	AOKI Mami
Executive Director	KUCHINO Shigeru
Auditor	INAMI Mitsutoshi
Auditor	FUJII Hidenori
Auditor	KIGUCHI Yataro

(As of March 31, 2012)

Trustees

Name
KAKINUMA Hirohiko
SEINO Satoshi
ISHIJI Tsuguo
YAMADA Yoshiomi
NODA Toyonori
SASAKI Takayuki
NISHIKAWA Naoki
IZUMI Masafumi
KARAIKE Koji
KOBAYASHI Masaaki
IWATA Sadao
SAWADA Jun
UMEZAKI Hisashi
YOSHINO Gentaro
MUKAIDONO Masao
ISHIKAWA Hiroki
KOBAYASHI Toshio
KAKUMU Masahiro
KENJU Toshikazu
ISHIWATA Tsuneo

(As of March 31, 2012)

Overview

Income and Expenditure in FY 2011

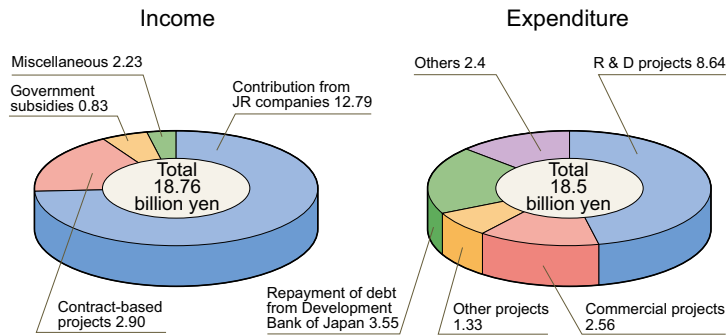

Human Resources

Number of employees	533
Number of PhD Degree holders	165

(As of April 1, 2011)

Number of Projects

Numbers of Themes

Development of the levitated railway		
Conventional railway	Projects	
	Inquiries about contracts	
	Basic research projects	
	R&D for the future railways	44
	R&D for practical technologies	128
	Basic research for railways	123
	Standards and surveys	13
Total		308

Relationship with Organizations in the Research Fields



Objectives and Mainstays of R&D in Activities

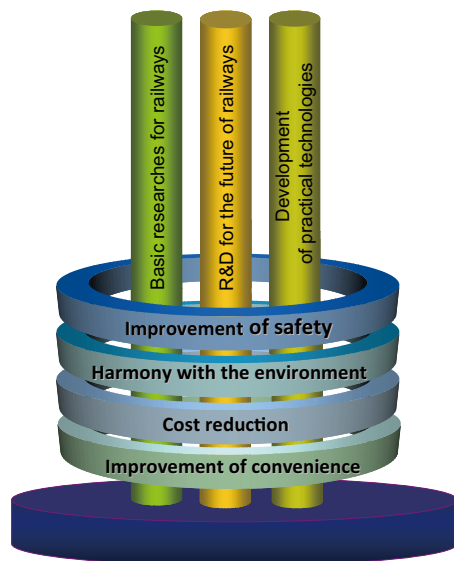

R&D for the Future of Railways

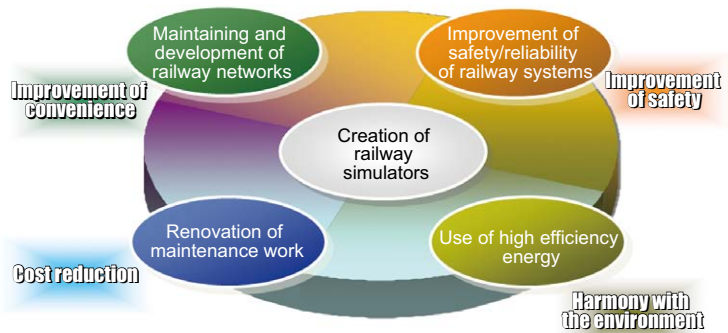

Medium and Long Term Master Plan – RESEARCH 2010 –

The master plan, RESEARCH 2010 was produced to describe research and development required for five years beginning in FY 2010 to effectively push ahead with activities to fulfill our commitment within various circles as a research institute capable of integrating many railway technologies. The plan is directed towards the sustainable development of railways, while considering progress in research and development in the past and changes in the circumstances surrounding the railway industry that have occurred in recent years.

1 Basic Policies and Objectives

In preparing this plan, we adopted basic policies on its content in view of the circumstances surrounding RTRI and railways in Japan as a whole. Regarding the management environment of JR companies, changes in their financial contribution and other movements outside the organization, we set the term of the plan at five years from FY 2010 to 2014, to account for the fact that it will take a certain length of time to carry through the “research and development for the future of railways” as referred to later, though it is difficult to correctly predict the trend in long-term future needs.

For RTRI having responsibility to society as a public-interest corporation, it is important to effectively perform its commitment to JR companies and other stakeholders through publicly disseminating research results to support railway business in the future. To this end, we shall make efforts to freshen up the targets of research and development set in the past, such as the improvement of safety and reliability, development of solutions to environmental problems on a global scale, achievement of harmony with the wayside environment, decrease system costs and the pursuit of comfort and convenience of passengers. As a new research challenge, we shall also aim at improving our simulation technology and try to expand our core competencies. We shall also review the organization

for research and development needs and capabilities at all times to respond to the changes in the internal and external circumstances and make efforts to enhance the efficiency of our activities based on financial situations.

As development needs in the future are quite uncertain in different countries, we will review this plan regularly to take into account changes in social and economic conditions in the world.

As a guideline for carrying out research and development aimed at achieving safe and assured, highly reliable railways, with low environmental impacts and featuring low-costs and high-level convenience for customers, we set forth the following as the basic objectives of RTRI activities.

- (1) Creation of new technologies aimed at sustainable development of railways
- (2) Quick and correct response to meet customer needs
- (3) Timely transmission and dissemination of research results
- (4) Continued pursuit of railway technologies and accumulation of basic technological knowledge
- (5) Effective use of this knowledge within the community of railway engineers

Evaluation and measures of car inside-comfort

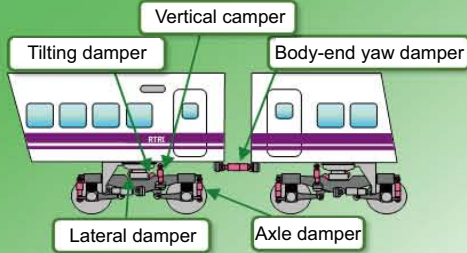

- A technique/measure to improve vibration ride comfort
- A technique/measure to reduce noise inside cars
- A technique to evaluate comfort inside cars

Smoothing the movement at traffic nodes



- Smoothing the movement at and around stations
- A diversified technique to evaluate train operation
- A technique to evaluate freight traffic

→ Establishment/evaluation of an environment for seamless movement

A new technology to monitor and maintain equipment conditions

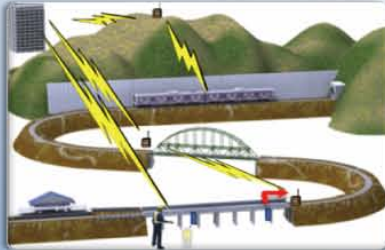

- A technology to monitor/maintain equipment conditions
- Basic technologies to monitor equipment conditions

→ A proposal of an equipment condition monitoring system

Innovation of the structure renewal technologies

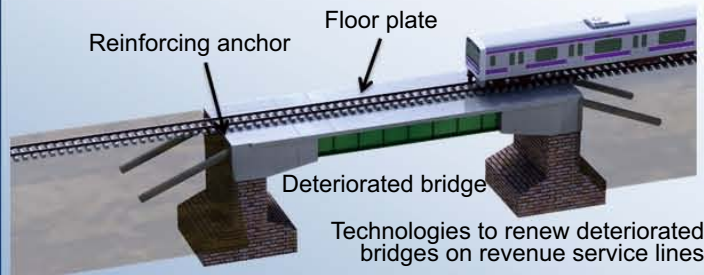

→ Renewal technologies for bridges, viaducts as well as underground and ground level stations

– RESEARCH2010 – Future (FY 2010)

Evaluation/measures to preserve the wayside environment for high speed operation

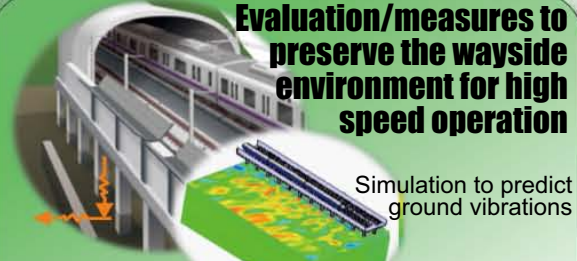

- A technique to evaluate aerodynamic noise/preventive measures
- Noise/ground vibration preventive materials

Sustainability and Development of Railway Networks

Construction of Railway Stations

Innovation of Maintenance

Design/development of a railway simulation

- ① Car, track and train simulation
- ② Simulation of the physical structure and wheel
- ③ A prototype virtual model
- ④ An integrated air flow and noise simulator
- ⑤ A contact wire/pantograph

→ A virtual

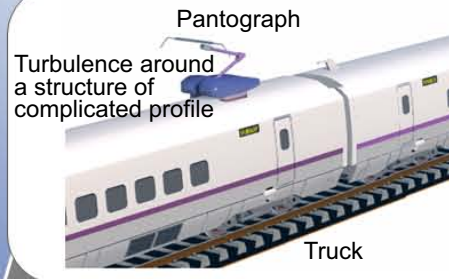

Future-Oriented Subjects (2010 - 2014)

Improvement of safety and reliability with intelligent trains

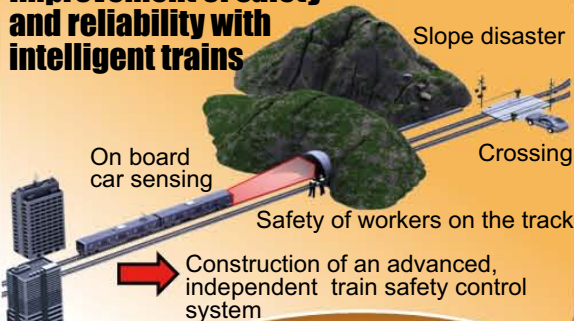

Improving the Safety and Reliability of the Railway System

Simulation of simulators

High-efficiency Energy Utilization

Development of motor core system

Simulation models
Simulation phenomena between
Railway test track
Flow and aerodynamic
Graph simulator
Virtual railway test track

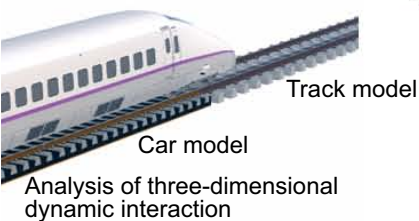

Improvement of the safety against derailment/collision

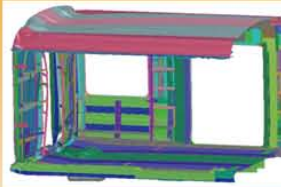
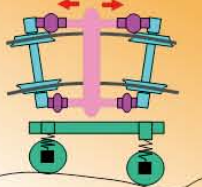

Raising the safety against meteorological disasters

- Simulation of the local meteorological conditions
- A technique to evaluate hazards
- A technology of disaster/hazard mapping

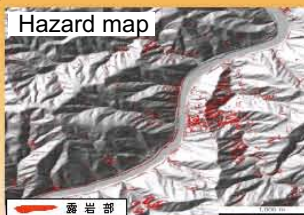

Real-time hazard mapping

Raising the safety against earthquakes

- A system to predict large-scale earthquake movements
- Evaluation of the safety of rolling stock running during earthquakes
- Earthquake-proof technologies/measures

An image of the prediction of earthquake movements

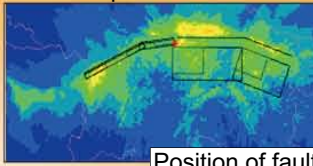

Reduction of car energy consumption

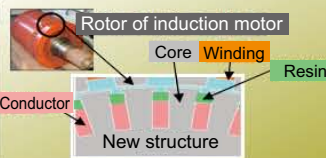

Lightweight cars made of new materials
High-efficiency car components
Decreases in car aerodynamic resistance

Low loss Rotator

A simulator to evaluate energy consumption

A new power supply system

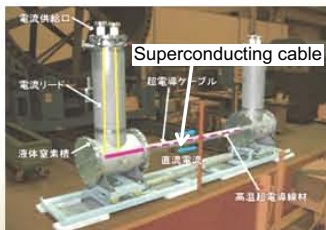

- Application of superconducting technologies
- Use of semiconducting elements of low loss
- Utilization of natural energy

Simulator of power consumption in train operation
Evaluation of train operation diagrams reflecting the constraint in power supply

2 Project Activities

2.1 Research and Development

(1) Promotion of Research and Development

(a) Targets of research and development

Amid the increasingly severe surroundings, we set the following four items as the “targets of research and development,” in consideration of the serious accidents/disasters and difficult economic circumstances in recent years, based principally on the targets of research and development in the past.

We further aim at achieving:

- Increased level of safety
- Harmony with the environment
- Low-cost railways
- Improved convenience for customers

(b) Poles of research and development

Recognizing that we have limited resources, to effectively carry out research and development, we set the following three items as the “corner stones of research and development,” with efforts concentrated in particular on the enhancement of the simulation technology for all the three:

- Research and development for the future of railways
- Development of practical technologies
- Basic research for railways

(2) Research and Development for the Future of Railways

In the field of research and development for the future of railways, we undertake basic research to better understand phenomena and to construct tools from which a “game-changing” breakthrough is expected for research and development. We also carry out research oriented to technological development having a far-reaching effect after commercialization.

(3) Development of Practical Technologies

We are pushing ahead with the development of practical technologies in the following areas:

- Technological development specified by the seven JR companies (six under-taking passenger transport services and one devoted to freight transport)
- Contract-based research and development

- Development of practical technologies performed based on our own initiatives

(4) Basic Research for Railways

We believe the basic research for railways will lead to practical technologies, which are essential to solve various railway-related problems, and/or will lead to further work which we might define as “analytical research projects” and “those to explore further research.”

(5) Others

(a) Transmission of information

We will positively collect, store and transmit information on railway technologies in Japan and abroad and present the results of these research/development activities in a timely manner.

(b) International activities

We will positively participate in various international conferences, make efforts to continue to exchange information on railway technologies with overseas researchers, and send staff abroad to survey the status of the railways and technologies in foreign countries. We will also push ahead with joint research projects, exchange researchers, strengthen the cooperative relations with overseas universities and research institutes and enrich the information transmitted to other countries.

(c) Railway Technology Promotion Center

Having a bird’s eye view over the railway industry as a whole, the Railway Technology Promotion Center will assess the technological needs common to all its member railway companies and solve their problems so that they can correctly respond to the expectation of society.

(d) Railway International Standards Center

The Railway International Standards Center will integrate the discussions on wide-ranging international standards on railways, thereby contributing to railway companies as a whole, while positioning the discussions on the strategy of international standardization, reviews of international standards and collection/transmission of the information received.

Statement of Activity Results 2011

1 Test and Research Projects and Major Results of Research and Development

In FY 2011, we pushed ahead with research and development on 308 themes and successfully completed research on 141 themes. Major Results of the Research and Development are shown below.

Improvement of Safety

(1) A practical system for the program to improve drivers' ability to respond to abnormal situations

- Development of an easy-to-use training system for instructors that allows voluntary learning as a practical system for the program to improve drivers' ability to respond to abnormal situations
- Verification of the effectiveness of the system for training evaluated by staff with experience of train operation

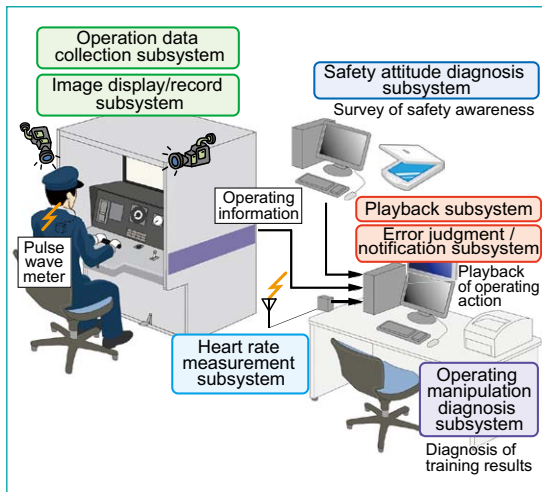

Fig. 1 A system composition incorporating seven subsystems

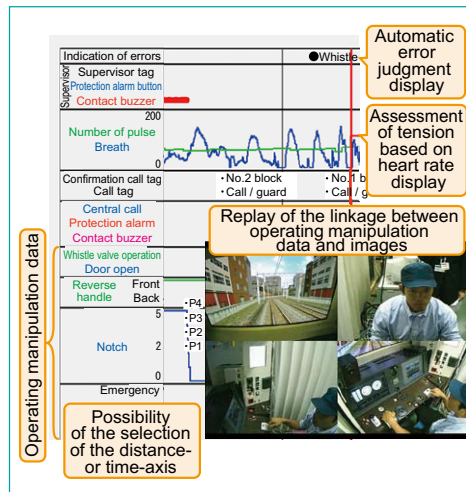

Fig. 2 Playback subsystem screen (with two displays in parallel)

(2) A technique to evaluate the crashworthiness of cars in collisions at level crossings by taking human behavior into consideration

- A survey of serious level crossing accidents in recent years and assessment of typical collision conditions at level crossings
- Establishment of a technique to evaluate the crashworthiness of the leading car based on the degree of train crew injuries
- A proposal of conceptual measures to improve the crashworthiness of driving cabs against level crossing accidents

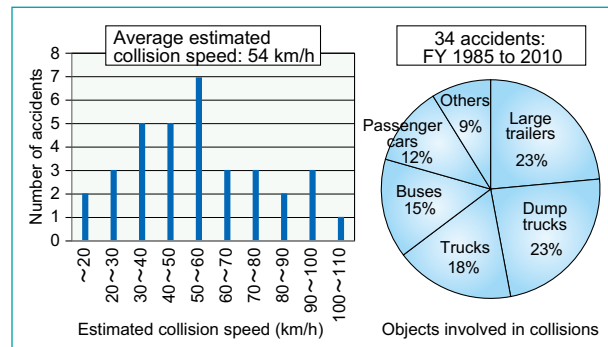

Fig. 1 A statistical survey of serious level crossing accidents

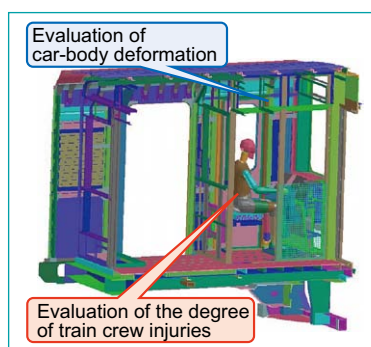

Fig. 2 An EFM model to evaluate the degree of train crew injuries and car-body deformation

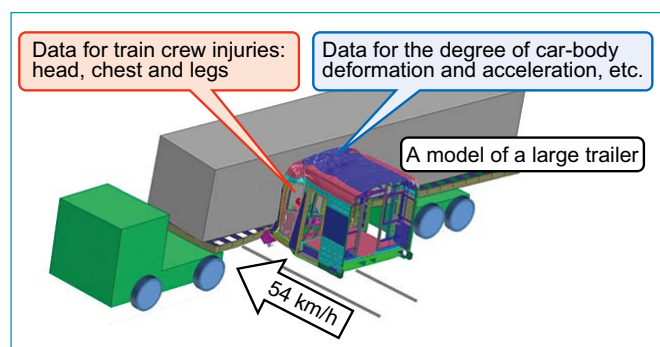

Fig. 3 An example of the analysis under typical collision conditions at level crossings

(3) Axle profile to improve fatigue strength where the wheel is fitted to the axle

- A proposal for an axle profile to improve fatigue strength where the wheel is fitted to the axle
- Confirmation of a significant increase in the fatigue strength of axles having the proposed profile through fatigue tests, stress analyses and evaluation of crack development caused by fracture mechanics

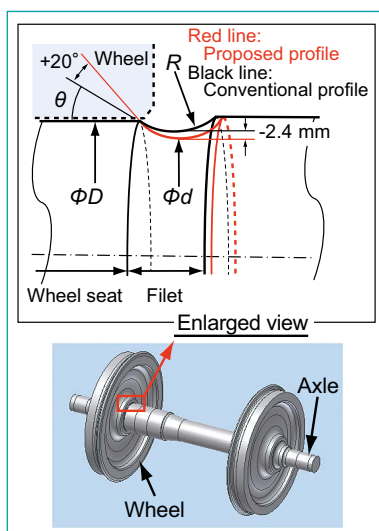

Fig. 1 Details showing the area of the axle where the wheel is fitted

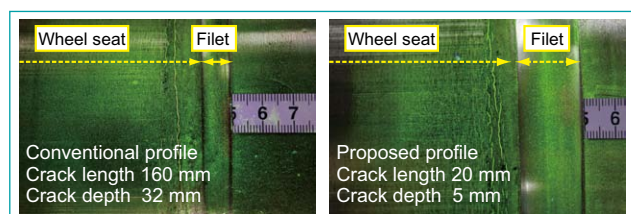

Fig. 2 Results of the magnetic particle inspection of a test axle

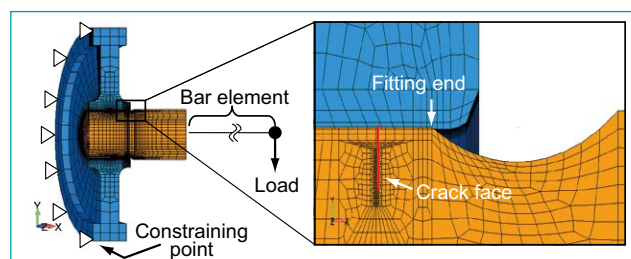

Fig. 3 Analysis model

(4) A technique to predict the sequence of earthquake movements including the main shock and aftershocks

- Establishment of a technique to predict the occurrence of aftershocks and their scale over time after a major earthquake
- Development of a technique to predict earthquake movements in wide frequency bands occurring across an extensive area between the main shock and aftershocks

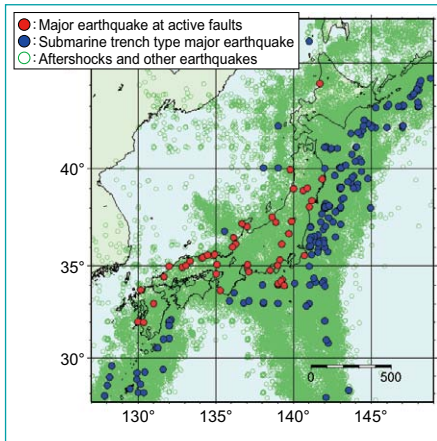

Fig. 1 Distribution of epicenters used for aftershock evaluation

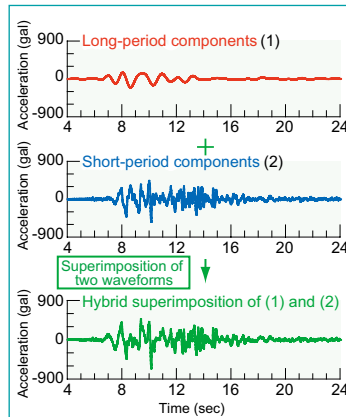

Fig. 2 Prediction of seismic movements using this technique

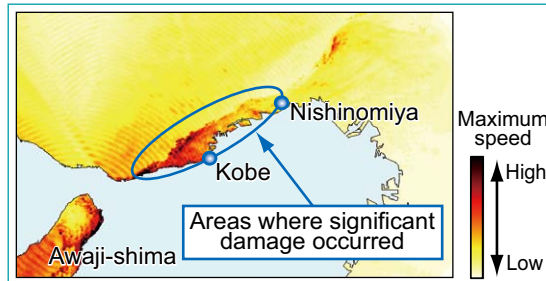

Fig. 3 Results of the evaluation of earthquake movements during the Hyogoken-Nambu Prefecture Earthquake in 1995

(5) Techniques to precisely locate the epicenter based on P-wave data and to effectively issue warnings against the S-wave

- A proposal for a new technique to locate the epicenter using data about the P-wave at a single observation point
- A proposal for a technique to effectively issue simultaneous wide-range S-wave warnings of major earthquakes by detecting when the vertical acceleration of the S-wave exceeds the specified value at several observation points

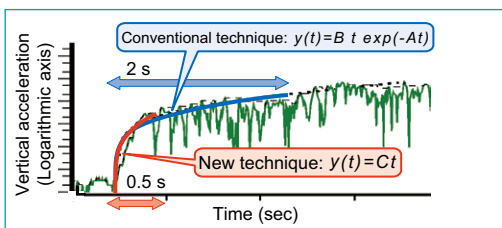

Fig. 1 An approximate function to estimate the distance to the epicenter and the time taken to analyse the data

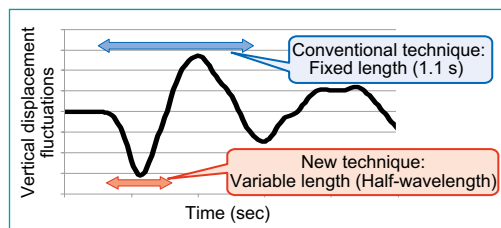

Fig. 2 Half-wavelength data of variable length used to estimate the direction of the epicenter

Table 1 Variation of the estimated distance to the epicenter

Technique	Data analysis time	Variation of the estimated distance to the epicenter (in the case where the true value is 100 km)
New	0.5 s	53 ~ 189 km
Conventional	2.0 s	49 ~ 206 km ↑12% up

Table 2 Variation of the estimated direction of the epicenter

Technique	Data analysis time	Errors in the estimated distance to epicenter (Difference between the true and estimated values)
New	Variable length ↑ Cut to 64%	49.0°
Conventional	Fixed length	67.9° ↑28% up

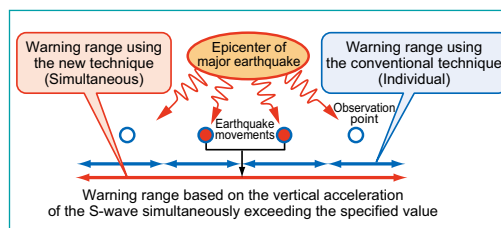

Fig. 3 A technique to issue S-wave warnings based on the vertical acceleration of the S-wave exceeding the specified value at several observation points

(6) Development of a technique to locate and reinforce damage sites in PC beams caused by breaks in the main steel

- Development of a technique to locate damage sites in PC beams caused by breaks in the main steel wire
- Development of a method to reinforce the located damage sites with steel plates

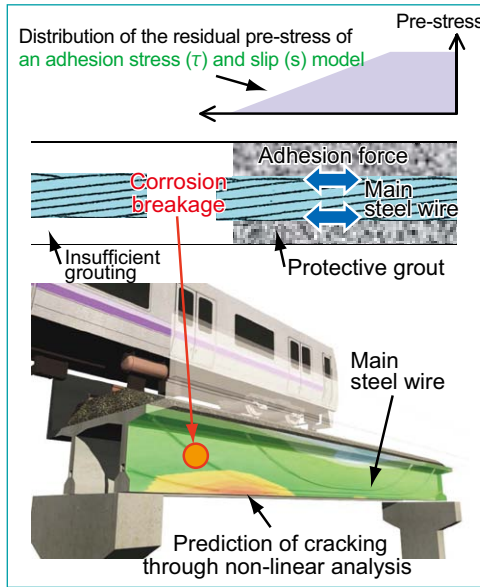

Fig. 1 A model of force transmission through adhesion and prediction of damage

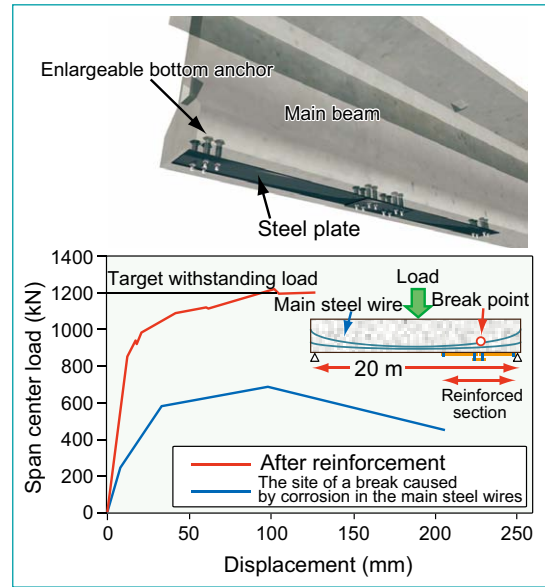

Fig. 2 Effect of reinforcing work at the damaged site

(7) A technique to calculate the characteristics of slopes that are liable to rupture or become a source of falling stones using digital elevation and surface layer models

- Clarification of the topological and vegetative conditions common to all slopes subjected to rupture
- Development of a technique to calculate slopes that are liable to rupture and expose rocks that may cause stones to fall using digital elevation and surface layer models

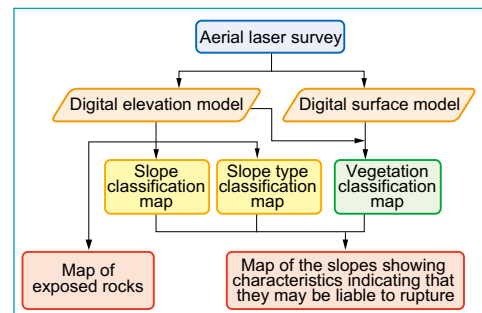

Fig. 1 Flow chart to create drawings for the calculation

Degree of contribution	Inclination	Slope type	Vegetation
High	30° or over	Concave valley type	Cutover (immediately after falling)
		Flat plate valley type	
		Flat plate straight type	
		Concave straight type	Cutover (early-age secondary forestation)
		Concave ridge type	
Less than 30°	Less than 30°	Flat plate ridge type	Coniferous trees (early-age)
		Convex ridge type	
		Convex straight type	Other vegetations
		Convex valley type	

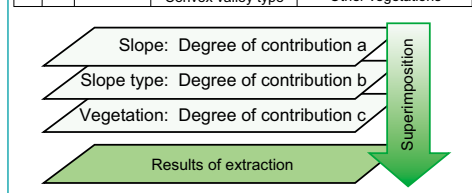

Fig. 2 Factors to contribute to the occurrence of slope rupture and their superimposition

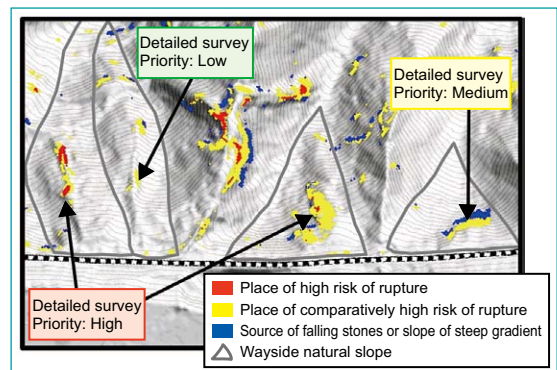

Fig. 3 Results of the calculation carried out to identify the places where slopes are liable to rupture and become a source of falling stones

(8) A technique to evaluate the rainfall resistance of embankments with drain pipes installed

- Establishment of a technique to evaluate/analyze the rainfall resistance of embankments with drain pipes inserted
- Quantitative evaluation of the effect of drain pipes to lower the levels of water and pore water pressure to determine the approximate specifications for implementation

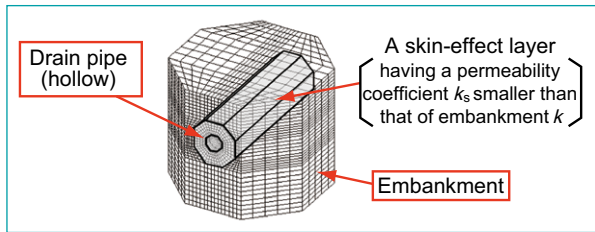

Fig. 1 An analysis model for a drain pipe

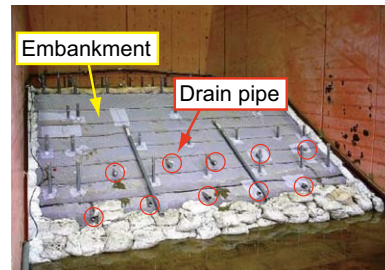

Fig. 2 An embankment test using a life-size model

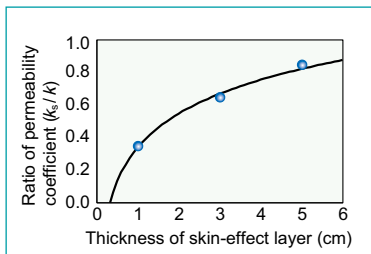

Fig. 3 Relationship between the thickness of skin-effect layer and permeability

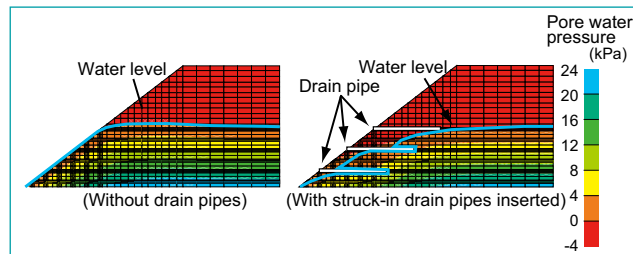

Fig. 4 Distribution of water levels and pore water pressure values obtained with the proposed analysis model

(9) A technique to analyze the buckling and large-scale deformation of ballasted track

- Development of a technique to analyze the stability against buckling and large-scale deformation behavior of ballasted track
- Quantitative evaluation under different conditions of the influence of seismic vibrations and temperature changes in the normal state

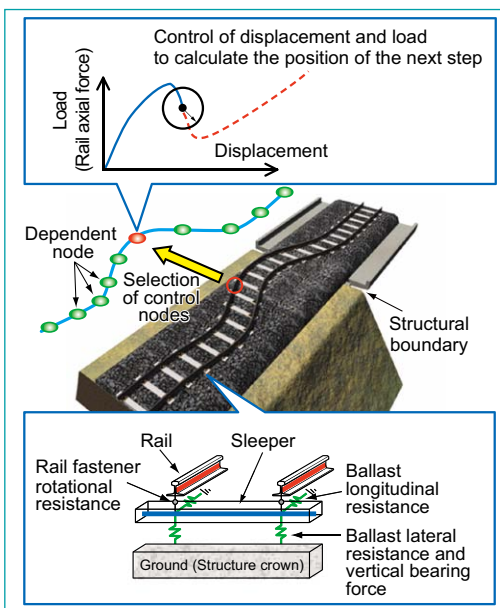

Fig. 1 Conceptual drawing of the analyzing technique

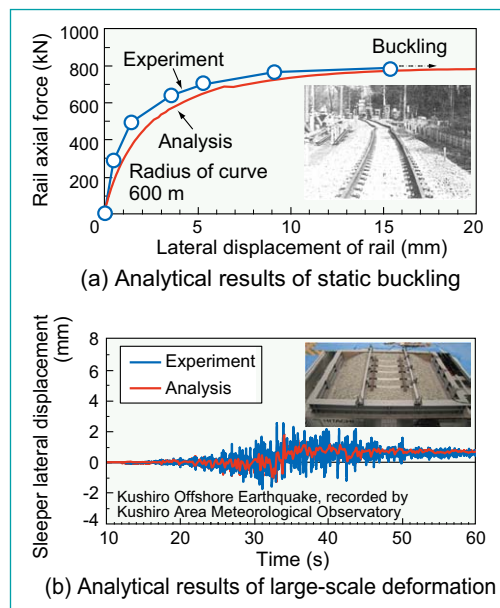

Fig. 2 A case of verification by the analyzing technique

(10) A technique to estimate the probability of thunderstorms causing disastrous damage to signalling systems in lightning strike conditions

- Development of a technique to estimate the probability of thunderstorms damaging to signalling systems
- Applicability of the estimating technique to determine if measures should be taken to prevent thunderstorms from causing damage to signalling systems

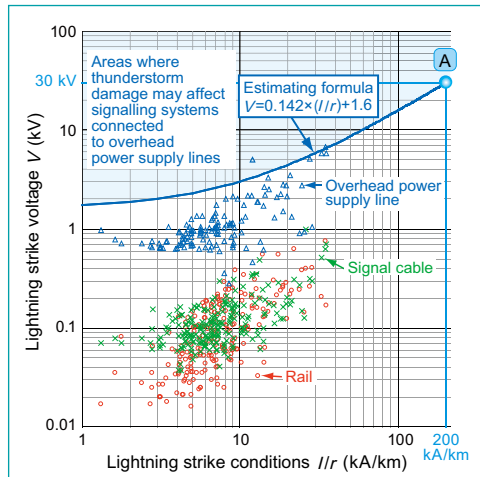

Fig. 1 Estimation of lightning strike conditions that may cause damage in a thunderstorm

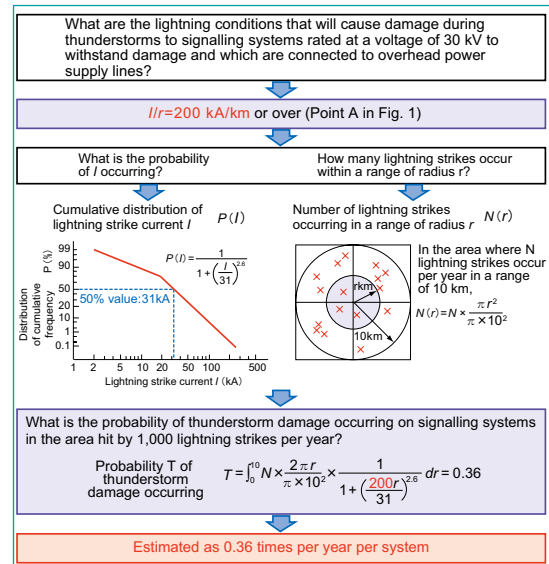

Fig. 2 An example of the estimation of damage to signalling systems during thunderstorms

(11) A technique to check the integrity of design specifications for train control systems

- A proposal for a format of requirements to efficiently check the integrity of design specifications for train control systems and a technique to utilize the format to check the safety of system functions
- Reduction of workloads to prepare design specifications and check the safety of system functions

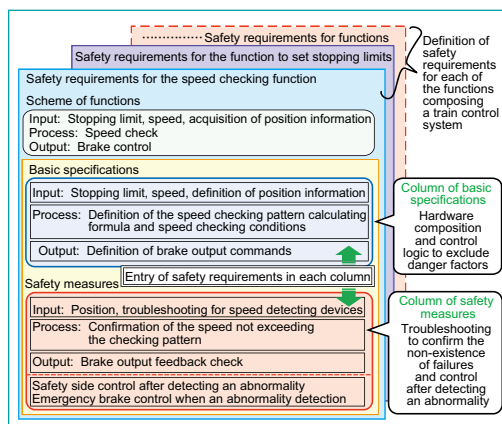

Fig. 1 A proposed format of safety requirements

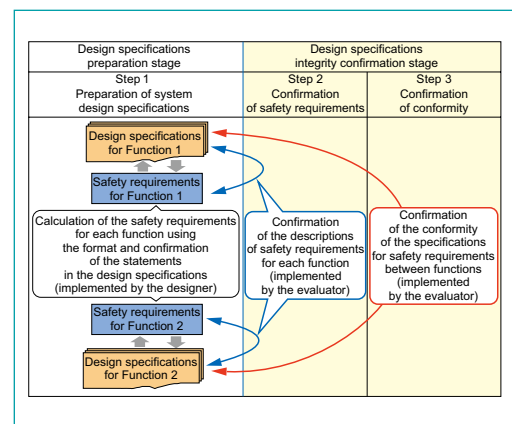

Fig. 2 The total flow of the technique to check the integrity of design specifications using the format (in the case of two functions)

Harmony with the Environment

(1) A simple technique to calculate the energy consumption of rolling stock

- Development of a simple technique to calculate the amount of energy consumed by EMUs and DMUs without relying on running test simulation
- Clarification of the details of energy consumption at errors of 10% or less

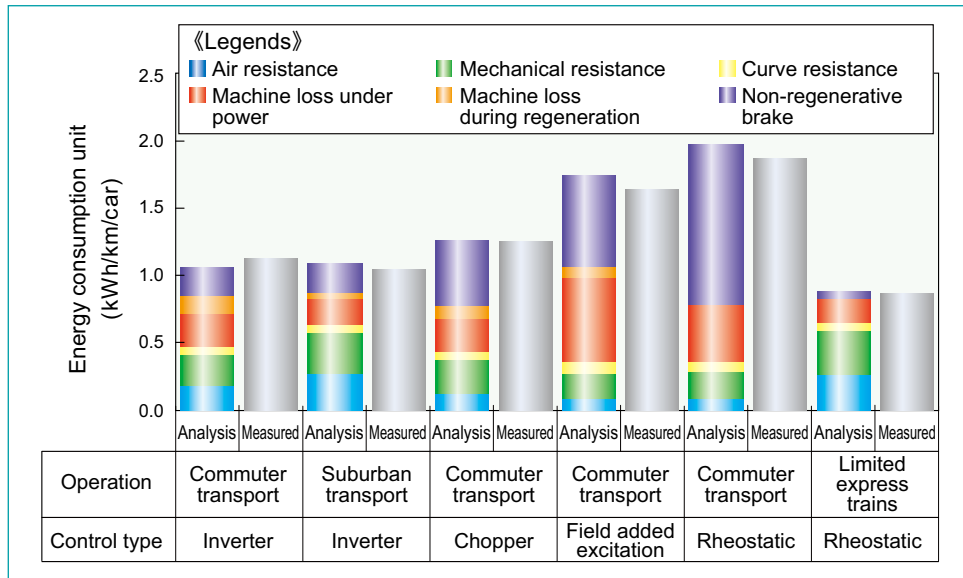

Fig. 1 A comparison between the calculated and measured energy consumption levels for a variety of EMUs

(2) A system to visualize the spatial distribution of a magnetic field

- Development of systems to quickly and easily measure the distribution and strength of the magnetic field inside and outside rolling stock
- A scanning system to measure the magnetic field and identify its precise co-ordinates with a single magnetic sensor
- A matrix system to visually observe the distribution and strength of the magnetic field

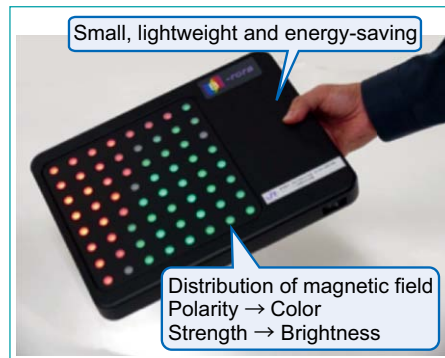

Fig. 2 A matrix system

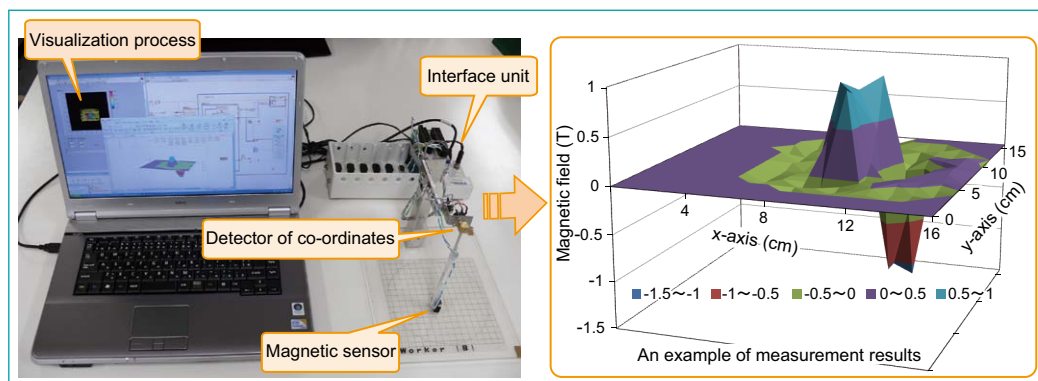

Fig. 1 Composition of the scanning system and an example of measurement results

Cost Reduction

(1) Synthetic brake shoes with an elastic structure to mitigate wheel damage

- Development of synthetic brake shoes with an elastic structure easily adaptable to wheel profiles
- Preventing the temperature of wheel treads from rising during braking to ensure improved braking performance during rainfall

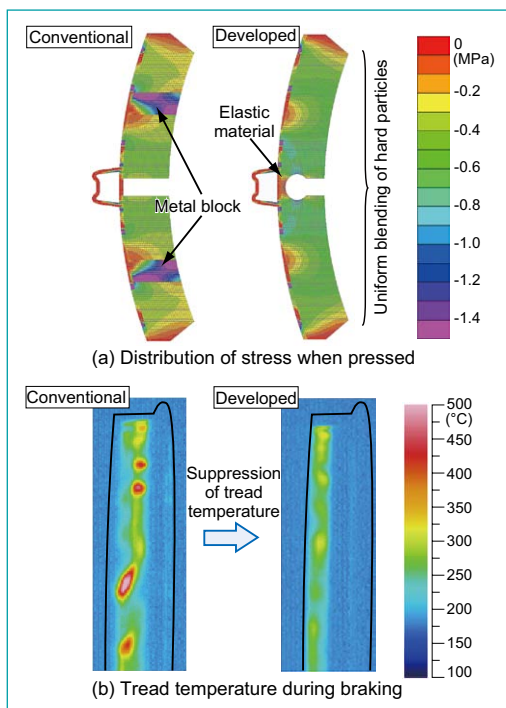

Fig. 1 Improvement of tread contact conditions

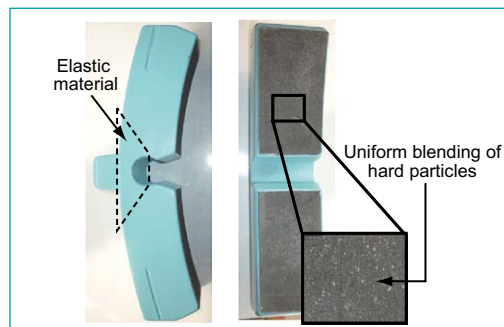

Fig. 2 A water-proof synthetic brake shoe with an elastic structure as developed by RTRI

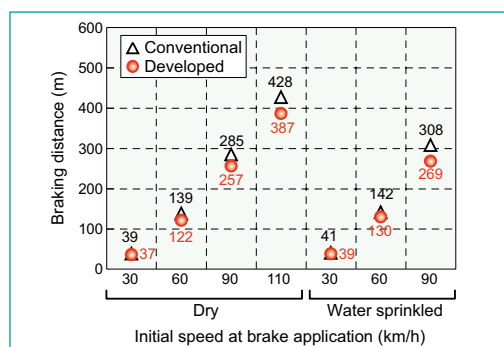

Fig. 3 Results of the performance tests of cars equipped with brake shoes featuring an elastic structure

(2) A system to support the rotation of container cars

- Development of a prototype system to support the preparation of container car rotation plans
- Prediction of freight car flows in the future based on the need to decide freight car mobilization schedules and a proposal for freight car inspection plans designed to cut the number of spare cars

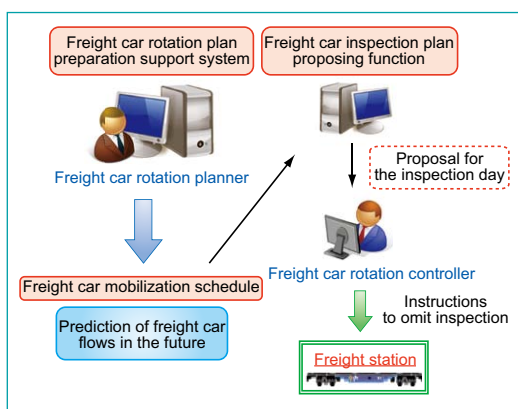

Fig. 1 Flow of services after introduction of the support system

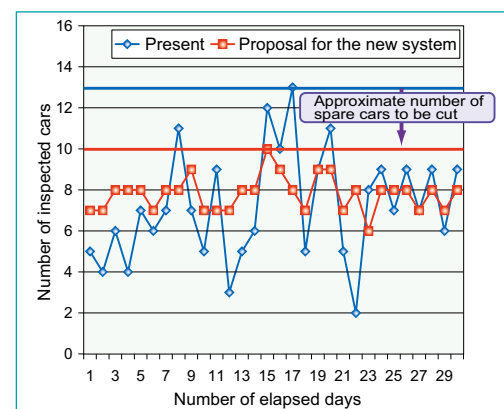

Fig. 2 A comparison of the number of inspected cars using the existing and proposed systems

(3) Techniques to create and evaluate the implementation of efficient train crew diagrams taking the roster sequence into account

- Development of a technique to create efficient train crew diagrams taking into account rest time at home, average working time and other roster conditions
- Development of a tool to compare/evaluate draft implementation plans and visualize the implementation evaluating values

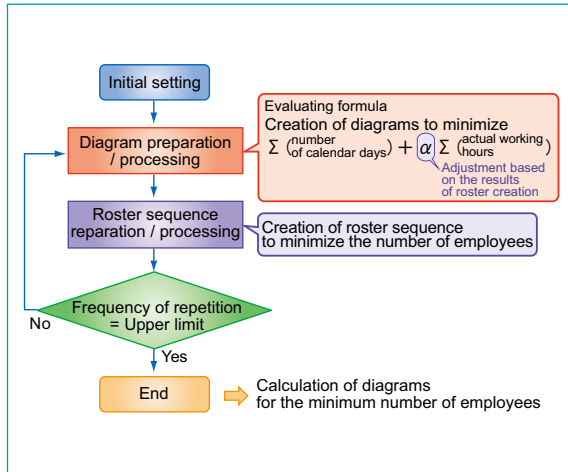

Fig. 1 Flow chart of the duty creating algorithm taking into account the roster sequence

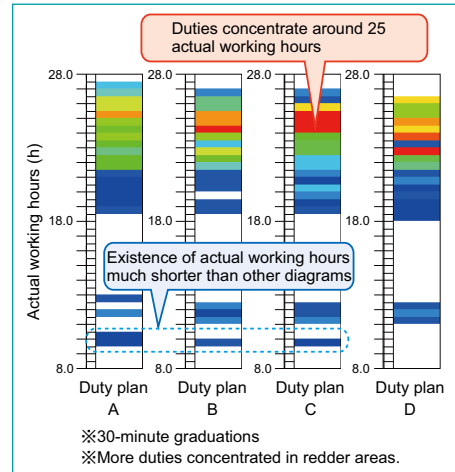

Fig. 2 An example of the display of the tool to visualize evaluation values (comparison of the distribution of actual working hours between different diagrams)

(4) A renewal technology for old bridges

- Development of methods to construct monolithic/composite structures of steel beams, abutments and embankments
- Reduction of cost to a half or less than that of steel beam replacement work

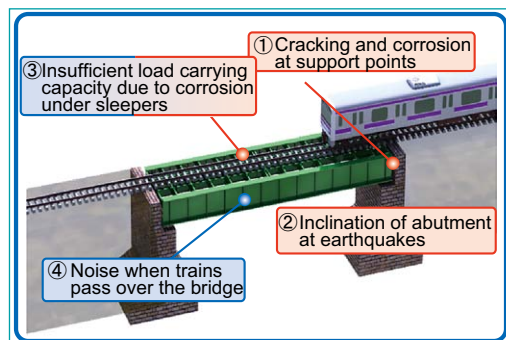

Fig. 1 Subjects for steel beam/abutment type bridges

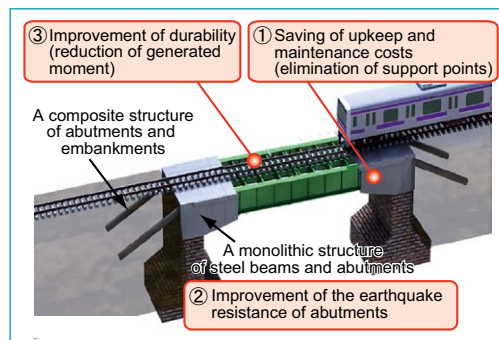

Fig. 2 Construction of a monolithic structure of steel beams, abutments and embankments (elimination of subjects (1), (2) and (3))

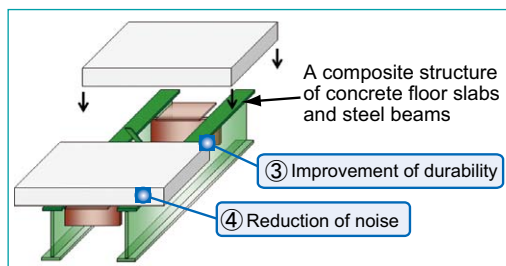

Fig. 3 Construction work of a composite structure (elimination of subjects (3) and (4))

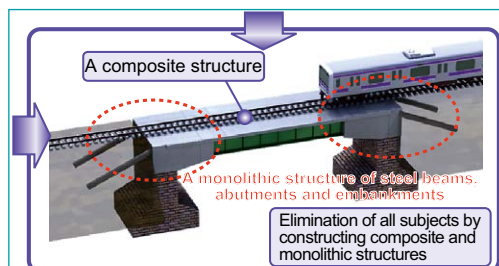

Fig. 4 A combination of composite and monolithic structures

(5) A crack detecting system for steel structures

- Development of a practical crack detecting system for steel structures using conductive paint
- Improvement of the efficiency of inspection

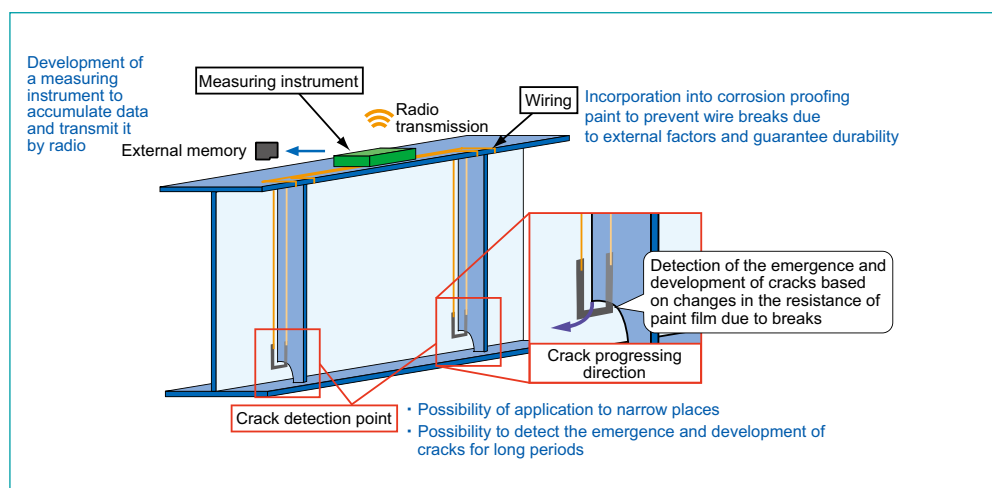

Fig. 1 An example of the composition of the crack detecting system

(6) A high-precision image processing technique to detect and evaluate cracks in tunnels

- Development of a technique to detect the position of tunnel cracks with an error margin of approximately 0.5 mm
- Development of an algorithm to calculate and produce tunnel ancillary structures to make a reference point to locate crack positions
- Development of an image processing algorithm to calculate the cracking density (degree of concentration)

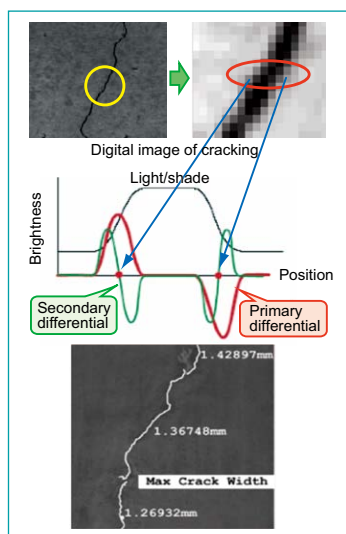

Fig. 1 A technique to detect cracks with high precision

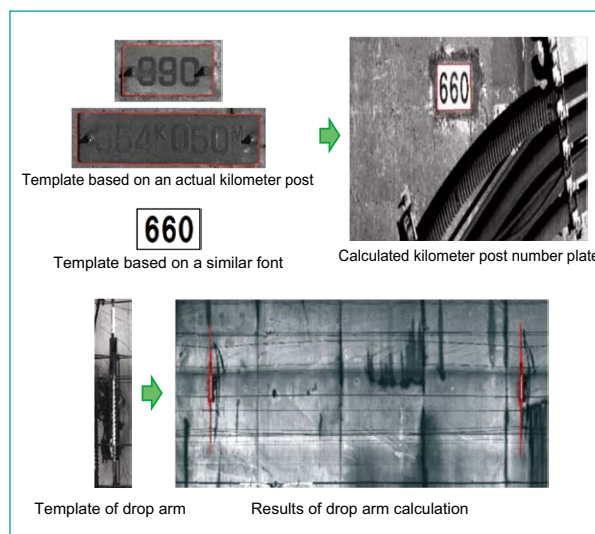

Fig. 2 Results of automatic calculation of tunnel ancillary structures

(7) An automatic settlement compensating sleeper

- Development of a sleeper with an automatic settlement compensating mechanism as a countermeasure against loose sleepers in ballasted track
- Confirmation of the reduction in track settlement to a value of 1/4 or less at the structural boundaries of the track and to a value of approximately 1/2 at rail joints through life-size track model loading tests

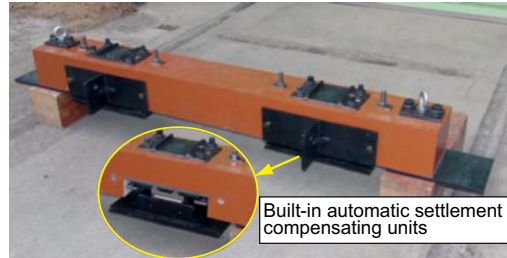

Fig. 1 Automatic settlement compensating sleeper (Type S)

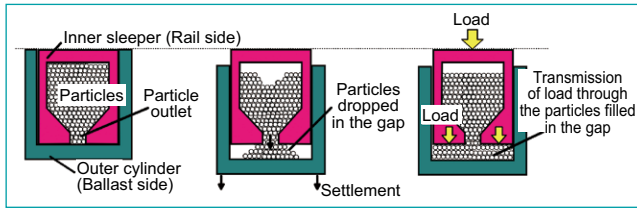

Fig. 3 Principle of automatic settlement compensating unit

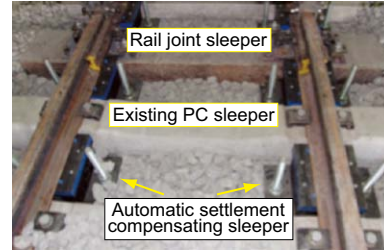

Fig. 2 Automatic settlement compensating sleeper (Type SS)

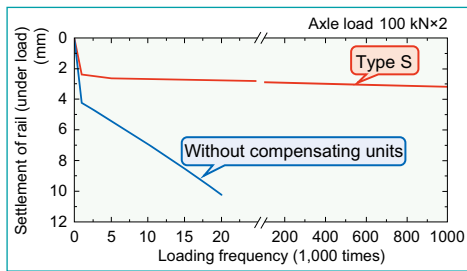

Fig. 4 A comparison of the differences in settlement at structural boundaries between the tracks with/without automatic settlement compensating units

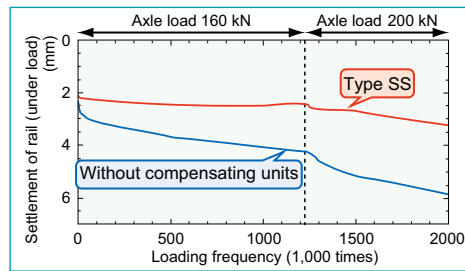

Fig. 5 A comparison of the differences in settlement at rail joints between the tracks with/without automatic settlement compensating units

(8) A model used to select appropriate categories of maintenance work to reduce the risk and cost of track maintenance

- Establishment of a model used to propose appropriate categories of maintenance work based on the evaluation of track displacement and material conditions using inspection history data, thereby aiming at reducing the risk and cost of track maintenance
- Application of the model to reduce track maintenance cost, derailment and other risks

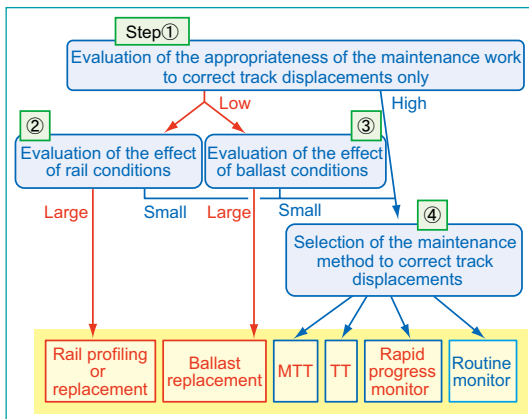

Fig. 1 A model to select categories of maintenance work

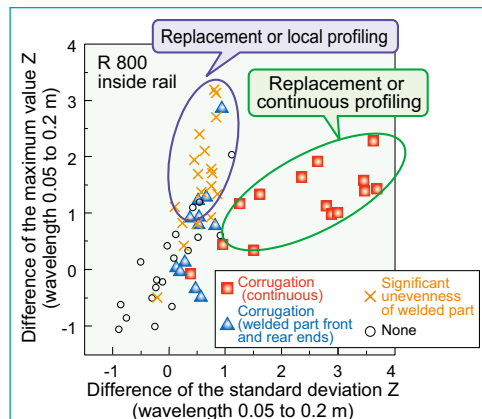

Fig. 2 Evaluation of rail conditions based on the difference between the right and left axle box accelerations and a proposal for work categories

Improvement of Convenience

(1) Commercialization of a vibration control system using vertical variable force dampers

- Commercialization of a vertical vibration reducing system using vertical variable force dampers installed in parallel to the secondary suspension system
- Significant reduction of vertical car-body vibration at 1 to 2 Hz to achieve a physical sensation of improved ride comfort

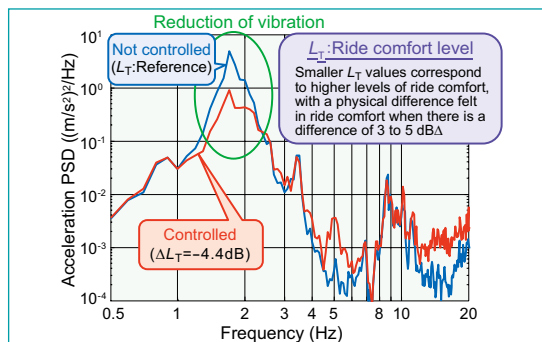

Fig. 2 An example of the vibration reducing effect of the vibration control system (vertical car-body acceleration PSD measured immediately above the truck at 73 km/h)

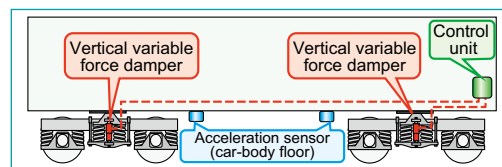

Fig. 1 Components of the vibration control system

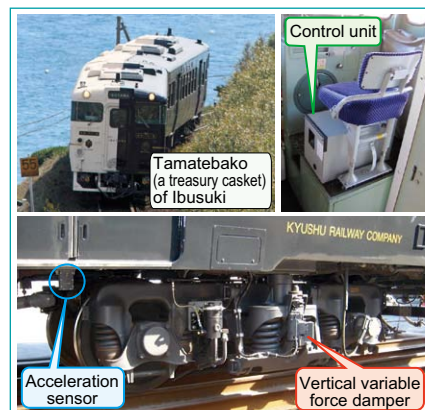

Fig. 3 Vertical variable force dampers and acceleration sensors installed on the limited express sightseeing train "Tamatebako (a treasury casket) of Ibusuki"

(2) A technique to suppress car-body vibration with quick-damping elastic supports for under-floor components

- Development of "vibration control supports" for under-floor components using quick-damping members to allow application to cars by simply changing the conventional under-floor component supporting system with a nominal increase in mass
- Reduction of car-body elastic vibration and suppression of the propagation of component vibration

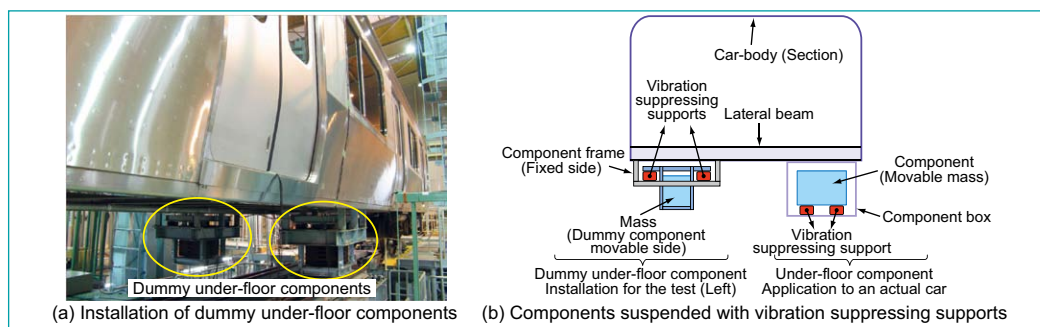

Fig. 1 A scene illustrating an exciting test at the rolling stock testing plant and a schematic drawing of the component support system using the vibration suppression supports (In this study, the damper suspenders are inserted between a dummy component and the component holding frame.)

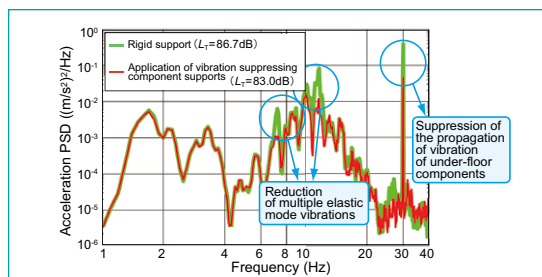

Fig. 2 Effect of vibration suppressing component supports Acceleration PSD at the car-body floor by the center windows (with L_T standing for vertical ride comfort)

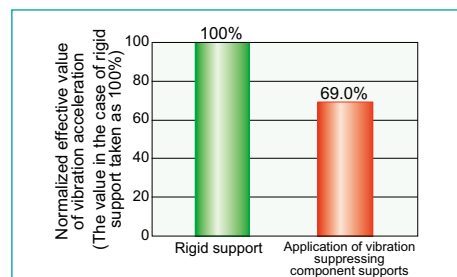

Fig. 3 Effective value of vibration acceleration on the movable side of the dummy component

(3) A technique to quantitatively determine the catchment areas for stations in competition with other transport facilities

- Development of a technique to determine the catchment areas where users exist for stations in competition with other transport facilities
- Calculation of the probability of users existing in the surrounding blocks, estimation of the number of boarding/alighting passengers, analysis of commercial areas and utilization for station market research

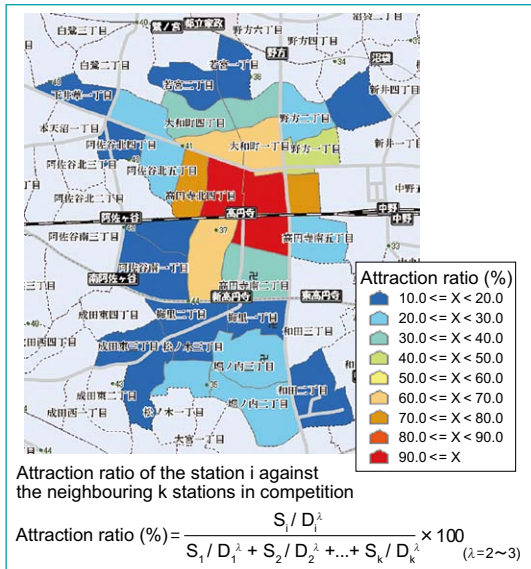

Fig. 1 An example of the calculation of catchment areas for different stations

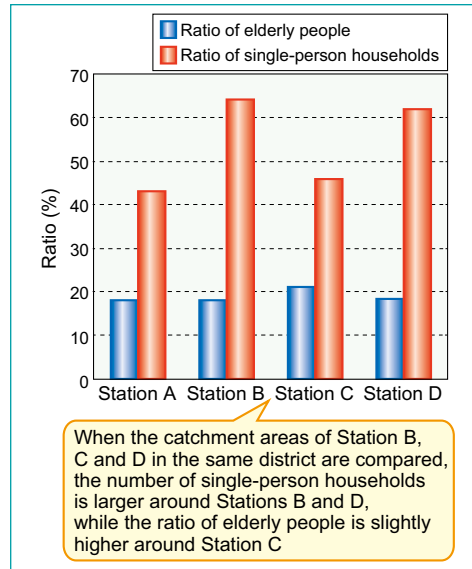

Fig. 2 An example of the analysis of the characteristics of people living in the catchment areas of different stations

Basic Research

(1) Quantitative evaluation of wheel flange contact face profiles

- Development of an ultrasonic measurement technique for wheel flange contact face profiles
- Application of the technique to quantitative evaluation of wheel flange contact face profiles

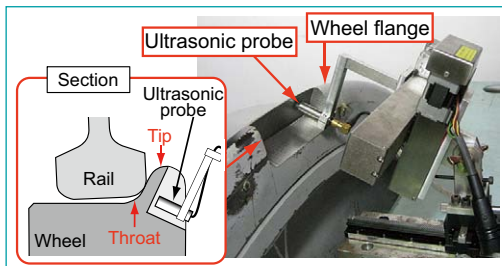

Fig. 1 Ultrasonic measuring system

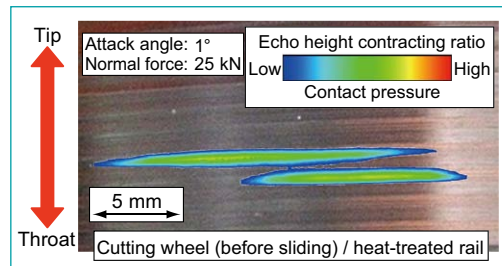

Fig. 2 An example of a measured wheel flange contact face profile

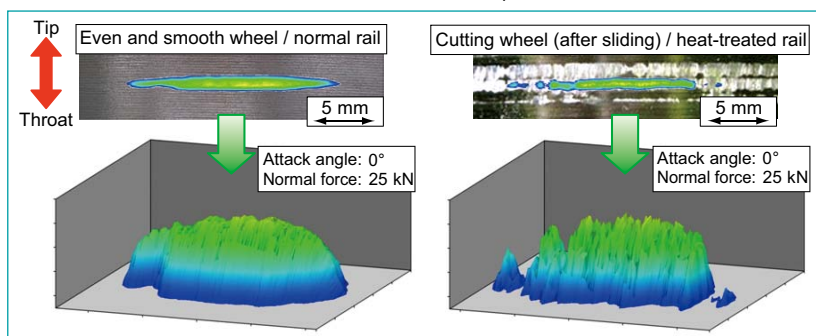

Fig. 3 An example of the distribution of echo height contracting ratios (contact pressure)

(2) A device to develop a car model completely analogous to actual cars

- Remodeling of test equipment to enable development of a car model completely analogous to actual cars in configuration with precise reproduction of micro-pressure waves and other aerodynamic phenomena related to tunnels
- Implementation of tests of train-generated winds, low-frequency noise and other aerodynamic phenomena in open sections

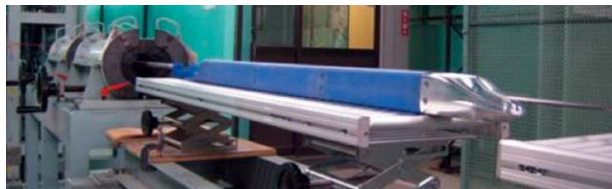

Fig. 1 A car model completely analogous to actual cars in configuration

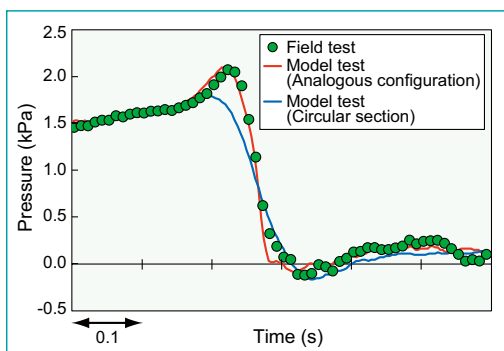

Fig. 2 Tunnel wall pressure during the passage of the nose of the leading car

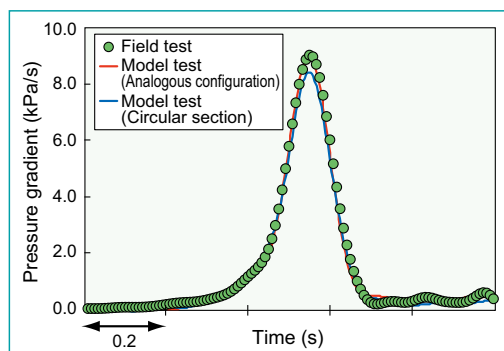

Fig. 3 The maximum pressure gradient of compressive waves at the entry of the nose of the leading car

(3) Evaluation of the stability of rock slopes by testing with a large-scaleshaking table

- Assessment of the dynamic behavior and collapsing mechanism of rock slopes by implementing simultaneous excitation tests in the horizontal and vertical directions of a life-size model on a large shaking table
- Possibility of the research results being applicable to the evaluation of the stability of wayside natural slopes during earthquakes

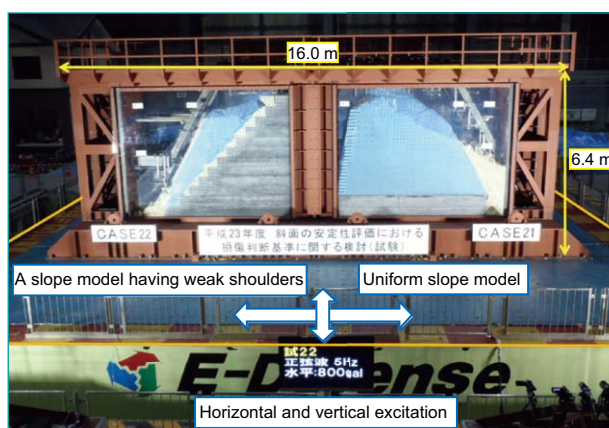

Fig. 1 A slope model test on a large vibration table

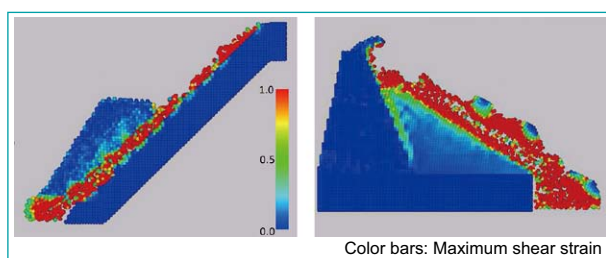

Fig. 2 A maximum shear strain contour by the particle method

(4) Investigation of the wear and arcing damage of current collecting materials in the energized state

- Clarification of the wear transition mechanism of current collecting materials in the energized state
- Clarification of the relationship of arcing damage with the current and arc duration time

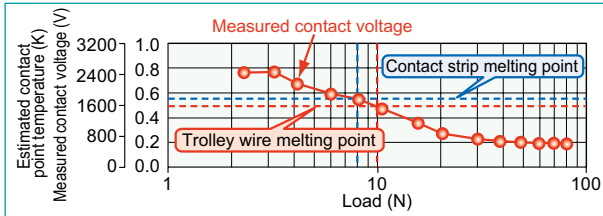

Fig. 1 Load versus contact voltage and contact-point temperature (at 100 A)

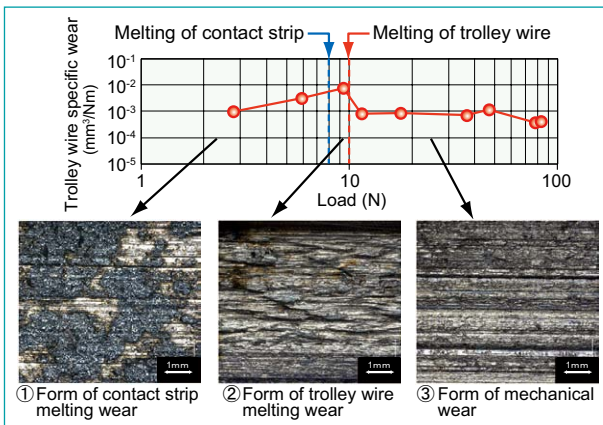

Fig. 2 Load and specific wear of trolley wire (at 100 A)

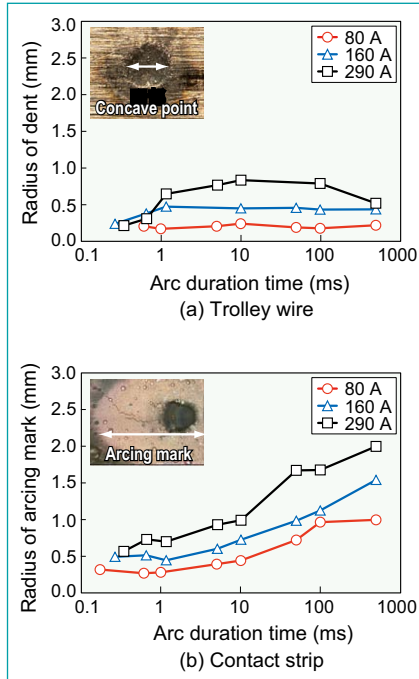

Fig. 3 Characteristics of arcing damage

(5) A technique to detect pantograph abnormalities by monitoring from the ground

- Development of a technique to detect the uneven wear of contact strips and abnormal aerodynamic upward force of pantographs using sensors on the ground
- Confirmation of validity of the technique using in-house tests

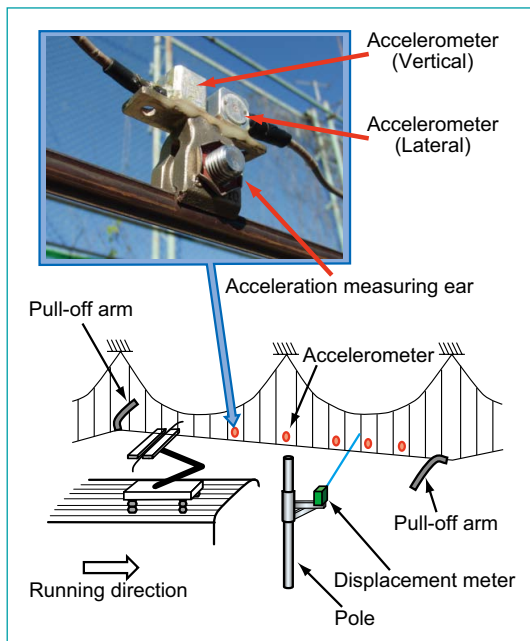

Fig. 1 Composition of the sensors to detect uneven wear

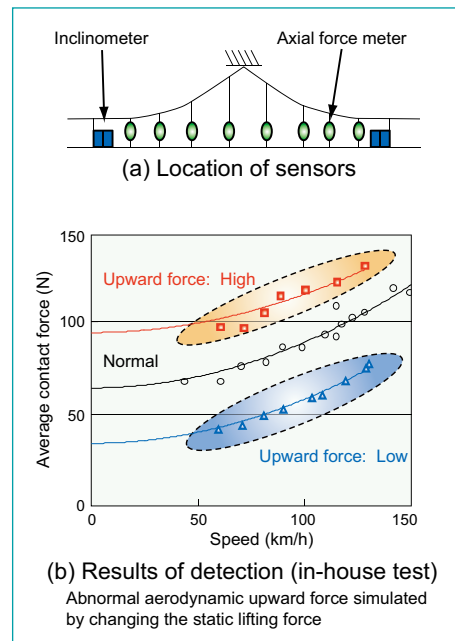

Fig. 2 Detection of abnormal aerodynamic upward force

(6) A flywheel power storage system using high-temperature superconductive magnetic bearings

- Development of a high-temperature superconductive magnetic bearing for complete non-contact support for a flywheel and a non-contact driving mechanism for rotation
- Realization of a small-scale system for non-contact levitation and rotation

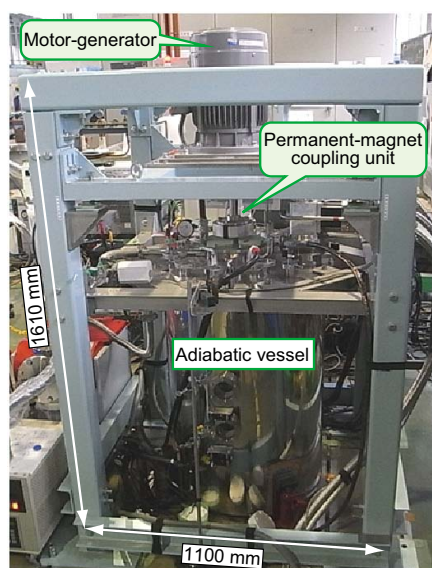

Fig. 1 A small test device to verify the high-temperature superconductive magnetic bearing system

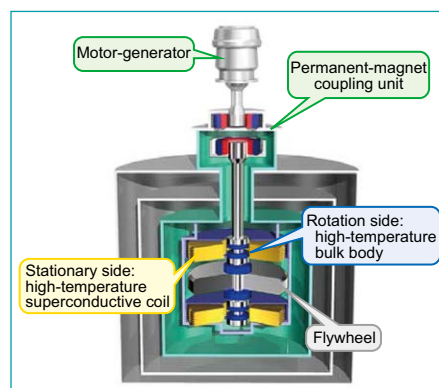

Fig. 2 An image of the superconductive flywheel

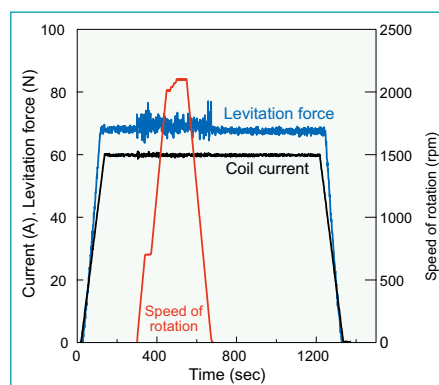

Fig. 3 An example of the test results with complete non-contact levitation and rotation

2 Projects for Public Interest

2.1 Research and Development Projects

In FY 2011, we pushed ahead with 308 research and development themes relating to the future of railways, as well as practical technologies and basic railway research. The research and development projects were financed by contributions from the trustees, and work was completed on 124 themes.

The funds for research and development amounted to 29.1 billion yen, including 470 million yen provided as subsidy by the government. In addition, we also undertook work on nine research and development themes contracted with the government and other organizations.

To improve the efficiency of research and

development, we also launched 16 contracted research projects and 62 joint research projects with universities and other research institutes, while making positive use of research and development reviews subject to evaluation and advice from eight learned and experienced research advisors from outside the organization.

2.2 Surveying Projects

We nominated a group dedicated to the promotion of survey activities for social and economic development. Regarding technologies related to railways in the future, we implemented a survey of a modular business model for railway industries. We seconded staff to the International Union of Railways

(UIC) to collect information on European railways and utilize it for our research and development.

2.3 Projects Involving Technical Standards

We made progress with the work to draft a design standard for composite steel and concrete structures (revision) and implemented surveys on the standard of earthquake-resistant railway structures, measures to prolong the life of existing earth retaining walls, rolling displacement of car-bodies and evaluation of the magnetic field inside railway vehicles. We also made progress with the development of design tools related to technological criteria.

2.4 Information Services

We collected information, publications and material on railways in Japan and abroad and released them through the Internet and document retrieval services. Customers were provided with the whole text of the periodicals issued by RTRI on its Home Page. We continued electronic archiving of the materials stored in the library, with the accumulated number of important electronic documents amounting to about 67,000 in total.

2.5 Publications and Lectures

We issued periodical and other publications: "Annual Report," "RRR," "QR," "Railway Technology Avalanche" and "Information on World-Wide Railway Technologies (WRT)." We also held an RTRI Lecture

(650 participants), 11 monthly presentations (1,156), 29 Railway Technical Lectures (1,290) and seven Lectures on Railway Structure Design Standards and other Technical Criteria (995).

2.6 Diagnosis Guidance Services

In response to requests from railway operators, we provided consultancy services on 390 occasions on a number of technical advisory issues including 11 rolling stock accidents, four power supply system problems, 10 track failures and 12 disasters.

2.7 International Standards Projects

We promoted activities on railway-related international standards for the International Electrotechnical Commission (IEC)/Technical Committee on Electric Facilities and Systems for Railways (TC 9) and International Organization for Standardization (ISO). Regarding IEC/TC 9, we held the 51th General Assembly in Fukuoka, Japan. As it was proposed to organize a Railway Technical Committee jointly by Germany and France, we decided to participate directly in its activities.

2.8 Qualification Authorizing Project

We organized examinations for 718 applicants seeking to qualify as railway consulting engineers on October 23, 2011 in Tokyo and Osaka, of which 134 were successful.

3 Commercial Projects

Against a target income of 3.34 billion yen, including that obtained by granting use of patents, we secured approximately 2.90 billion yen. To disseminate research results and promote profitable projects, we staged technology exchange meetings on five occasions for about 560 people in total from 200 companies and a technology exchange meeting in the Kansai area for about 330 people from 100 companies.

3.1 Research and Development Project under Contract

(1) Projects in the Public Interest

Regarding projects in the public interest, we were contracted to undertake survey and research projects on technical criteria with the government (90 million yen). We were also contracted to undertake nine projects on the evaluation of slope stability and others

with independent administrative juridical persons (470 million yen), securing an income of 560 million yen.

(2) Commercial Projects

Table 1 summarizes the number of customers and the amount of income from commercial projects in FY 2011. While the income from the government, municipal organizations and independent juridical persons dropped from that earned in FY 2010, the total income from JR companies, municipal and private railways and private enterprises increased.

Major project items contracted with those customers are a survey on international railway standards (government), system maintenance work for facilities and equipment (local public organizations), surveys on seismographs (Japan Railways companies), projected Shinkansen-related tests, surveys and research (independent juridical persons), management and upkeep of a structure control support system (municipal and private railways) and discussions on the construction of earthquake resistant structures (private enterprises).

Table 1 Classification of customers

Customer	No. of projects		Amount of income (100 million yen)	
Government	11	(19)	0.17	(0.89)
Local public organization	3	(1)	0.10	(0.41)
Japan railways	111	(80)	9.60	(4.39)
Independent administrative juridical person	42	(44)	6.13	(11.10)
Municipal / private railway	92	(85)	2.69	(2.22)
Private enterprise	306	(308)	10.34	(9.90)
Total	565	(537)	29.03	(28.91)

The figure in brackets refers to the previous year.

(3) Total Income

We secured a total income of 3.46 billion yen (the sum of income from public interest and commercial projects) in FY 2011, reaching 103% of the agreed target of 33.4 billion yen.

3.2 Railway Technology Promotion Center

While assessing technical needs common to railway/tramcar business promoters and local railway associations, we made progress with various projects in close co-operation with these businesses.

In the sphere of technical support, we dealt with 73 inquiries on technical subjects made by members from the Railway Technology Promotion Center, carried out three site surveys and made four advisory visits. We held forums on energy saving topics in railways in Tokyo, Nagoya, Osaka and Fukuoka and also gave lectures on four occasions at technical workshops organized by local railway associations. Furthermore, we compiled a text book on disasters for leading engineers and started compilation of a version covering rolling stock.

In the field of survey research, we promoted research on six themes in response to requests from members and completed three projects, including one on "the survey and research to suppress corrugated wear of rigid contact wires." We made efforts to disseminate information through the Home Page to provide members with information, collected information on railway accidents and incidents to store in the railway safety database and worked on compilation of an analytical report on the effect of natural disasters on transport.

3.3 Railway International Standards Center

Based on the policy and proposal presented by the committee on discussions and surveys for standardization of railway technologies, we carried out activities relating to international railway standards in the International Electrotechnical Commission (IEC)/ Technical Committee on Electric Facilities and Systems for Railways (TC 9) and International Organization for Standardization (ISO). For IEC/TC 9, we held the 51th General Assembly in Fukuoka, Japan, where we provided the secretariat. As it was proposed to organize a Railway Technical Committee jointly by Germany and France, we decided to participate directly in its activities.

Through information exchange with those concerned in foreign countries in Europe and Asia, we made efforts to collect information on railways and held meetings for liaison in different divisions and for

planning and strategies for international standardization, thereby meeting the needs of the committee members while promoting discussions on international standards.

Furthermore, we held five seminars on how to improve human resources and made information available to members and foreign countries via the Home Page.

3.4 Other Activities

3.4.1 Development of Gauge-Changing EMUs

To develop gauge-changing EMUs, we carried out measurements during running tests with a new type of car fitted with improved trucks, as a member of the

association to develop technologies for gauge-changing trains. After reaching a target speed (equivalent to that of the current limited express trains) during running tests on the JR Yosan Line, the new cars started running tests to verify durability.

3.4.2 Industrial Property Rights

We applied for 215 patents and utility models in FY 2011 (230 patents, etc. in FY 2010). By the end of the fiscal year, 215 cases were registered (165 within FY 2010). As a result, the number of patents and utility models owned reached a total of 2,201 at the end of FY 2011.

4 Administrative Organization

4.1 Operation

After changing its legal status to a public interest corporation on April 1, 2011, RTRI accepted full responsibility for its management duties, including the meetings of the Boards of Trustees and Executive Directors, under the new system. While extending support to the railways hit by the Tohoku Region Pacific Coast Earthquake, we cut operating costs in view of the severe financial picture. With regard to the issues of labour safety and hygiene, we took steps to ensure compliance, raised the morale of staff as a means to enhance safety and improved working conditions with a view to achieving safe and comfortable workplaces.

4.2 Human Resources

We recruited 24 new graduates and two mid-career employees to avoid technology gaps between generations and to preserve the potential for research and development. We also re-employed 12 retiring researchers, called "silver workers," to ensure the smooth transfer of technical knowledge and skills from veterans to young employees.

As part of a program of personnel exchanges, we seconded a total of 59 researchers to other organizations (including 25 to JR companies) and

accepted 100 researchers in return (including 56 from JR companies). The recipient organizations included the Ministry of Land, Infrastructure, Transport and Tourism (MLITT), Japan Railway Construction, Transport and Technology Agency, New Energy and Industrial Technology Development Organization (NEDO) and UIC, while the organizations who seconded staff to us included MLITT and private railway companies. Furthermore, eight researchers took office as visiting professors by request and 37 joined as part-time instructors from different universities.

We now have 165 PhDs, 81 consultant engineers, 19 registered metrological engineers and 6 first-class registered architects.

4.3 Improvement of Equipment and Facilities

We remodeled the structure loading test facility into a hybrid loading system to enable tests to be interlinked with numerical simulations. In total, 23 testing machines or devices were newly installed, improved and renewed.

Regarding other facilities, we carried out earthquake-resistant reinforcement work on the lecture hall and 11 test buildings, applied safety measures to renovate seven laboratories and implemented energy saving work at two worksites and other places.

4.4 Measures against Earthquake Damage

We strengthened the emergency stocks that are held in readiness for restoring operation of damaged equipment/facilities and revised the manual for action in case of earthquakes or in other emergency situations. Before that, we reviewed the method used to confirm the safety of employees and the system for urgent mobilization during off-duty hours. As an urgent power saving measure in the wake of the nuclear power plant accident in Fukushima, Japan, we adjusted the days when large-scale testing machines are operated and restricted the use of lighting apparatus and air-conditioning equipment.

4.5 Visitors

The Kunitachi Head Office Laboratory and the Maibara Wind Tunnel Technical Center had approximately 1,970 and 270 guests, respectively, in FY 2011. About 1,500 participants attended the RTRI Technical Forum held at the Kunitachi Head Office on October 21 and 22, 2011. In addition, approximately 4,900 people visited the RTRI open house festival on October 8, 2011.

International Activities

1 Joint Research with Overseas Research Organizations

In FY 2011, we pushed ahead with joint research projects in three framework programs with overseas railway research organizations. Each division also implemented joint research based on its own interests with railways and universities in foreign countries.

1.1 Joint Research with China Academy of Railway Sciences and Korea Railroad Research Institute

The tripartite joint research by Japan, China and Korea is being handled by the three parties after the two bilateral research programs (1) between RTRI and China Academy of Railway Sciences (CARS) and (2) between RTRI and Korea Railroad Research Institute (KRRRI) were combined into a single scheme.

Aiming at sharing research results and exchanging information, joint seminars have been held since 2001 by Korea, Japan and China under a rotation formula. In 2011, the 11th seminar, which was originally scheduled to be hosted by RTRI, was held in November in Beijing by CARS; the venue was changed to the capital of China because Japan was affected by the Tohoku Region Pacific Coast Earthquake.

The research themes promoted by RTRI are the derailment limit in high-speed running, methods for mutual use and control of testing facilities, adhesion between wheel and rail, standardization of EMC tests, restoration of contaminated soil, methods to investigate micro-organisms, comparison of performance in different environments, measurement technologies for trolley wires and pantographs, human factors, the effect of train vibration and data processing technologies from track measurements.

1.2 Joint Research with French National Railways

RTRI and Société Nationale des Chemins de fer Français (SNCF) have been carrying out joint research after the two parties concluded a protocol on joint research in November 1995. In May 2011, RTRI and SNCF held an interim meeting at the venue of WCRR2011 (Lille, France). The 5th joint research program is now in progress in the fields of inspection of overhead contact wires, ride comfort, wireless sensor networks and the management of research and development.

1.3 Joint Research with the Railway Safety and Standards Board, UK

RTRI concluded an agreement on joint research with the Railway Safety and Standards Board (RSSB) in the UK in October 2008, started joint research in December 2008 and in December 2011 exchanged information on the theme of increasing line capacity, taking into consideration the nodes or bottlenecks in railway networks.

1.4 Joint Research with Other Research Organizations

We are carrying out joint research in the field of information on transport with the Swiss Federal Railways under a collaborative research agreement and also with such universities/institutions as the University of Cambridge in the UK (facilities status monitoring), Massachusetts Institute of Technology in the US (high-temperature superconductivity) and Chalmers University of Technology in Sweden (air flow calculation method, rail/wheel contact fatigue).

2 Support for WCRR Sessions

The World Congress on Railway Research (WCRR) stems from the RTRI-sponsored Tokyo international seminar held in 1992 to which RTRI invited a number of leading members in the field of research and development from major railway operators and other organizations in different countries across the world. WCRR has since developed into an international conference attended by railway engineers from around the world who place particular emphasis on research among the themes of technological development. On the occasion of WCRR2011 held in May 2011, we

made efforts to collect sponsors and invite experts to contribute papers, while supporting the administration of the conference as a whole. We kept JR group stands opened at the venue, with more than 40 members from RTRI attending the general assembly and research sessions, including 34 speakers, executives and employees alike.

Preparatory work to support WCRR2013, to be held in Sydney, Australia, in November 2013, is now in progress by the Administrative and Executive Committee, along with executive and staff members.

3 Co-operation with Domestic Organizations

Through co-operation with the Ministry of Land, Infrastructure, Transport and Tourism, Japan, and related domestic organizations, we are contributing to bolstering relationships with overseas railway promoters. In FY 2011, we held lectures on rolling stock and electrical systems in Thailand in July, introduced RTRI's technical development at a TV meeting in Turkey

in August and offered technical information on EMUs with a hybrid power source in "the best approach book"; we also prepared information material for the ASEAN countries and accepted foreign trainees from universities in various countries and hosted a number of study tour groups.

4 Collection of Overseas Technical Information

We seconded staff to the International Union of Railways (UIC) to collect information on the technical research and development of railways in Europe. We participated in the UIC Asian Region Assembly held in Goa, India, in November 2011, the UIC general

assembly and the International Railway Research Board (IRRB) meeting held in Paris in December 2011 and the US Transportation Research Board (TRB) meeting held in Washington DC in January 2012.

5 Dissemination of Information

In 2011, we issued the Annual Report 2010 (English version) and the Newsletter "Railway Technology Avalanche" four times, which introduces the recent activities of RTRI. In parallel, we started preparing the

submission of information to the Sharing Portal for Access to Rail Knowledge (SPARK), an information sharing site owned by RSSB.

6 Overseas Visitors to/from RTRI

Tables summarize the number of overseas visitors, respectively, from/to RTRI.

Table 1 Number of overseas visitors from RTRI (By purpose)

	Asia	Europe	North America	South America	Oceania	Total
WCRR	0	39	0	0	2	41
Conference/meeting	30	75	18	1	2	126
Survey/Research	8	2	3	0	0	13
Joint research	19	14	2	0	0	35
Technical guidance	1	0	0	0	0	1
Contract	14	8	0	1	0	23
Miscellaneous	38	30	1	0	0	69
Total	110	168	24	2	4	308

Table 2 Number of overseas visitors to RTRI (By country)

Asia	Europe	North America	South America	Africa	Total
192	67	9	2	9	279

7 Railway International Standards Center

To facilitate smooth operation of the Railway International Standards Center, we hold a planning/operation consulting meeting with those representing the members working for the Center twice or more a year to discuss business plans, budgets for balance of payment, business reports, acceptance/withdrawal of members and other important issues related to the operation of the Center. To maintain close communications with members, we hold a member liaison meeting twice or more every year to ensure positive opinion exchanges among members.

7.1 Operation and Management

(1) Planning/Management Consulting Meeting

We held the Planning/Management Consulting Meetings in May 2011 and February 2012 to discuss the business report on FY 2010 and the business plans for FY 2012.

(2) Settlement of Accounts in FY 2011

Income in FY 2011 was: approximately 87 million yen from membership fees, one million yen from grants, 90 million yen from JR contribution fees and 43 million yen appropriated from the general account (carried forward from FY 2010), in all amounting to approximately 221 million yen.

The expenditure was: approximately 105 million

yen for business promotion, 34 million yen as travel expenses and 70 million yen as personnel expenses, which amount to approximately 212 million yen in total.

(3) Number of Members

The new entrants in FY 2011 were 26 juridical persons/groups, which bring the total number of members to 109 juridical persons/groups as at the end of FY 2011.

(4) Members Liaison Meeting

We held member liaison meetings in May 2011 and February 2012, when we reported the proceedings at the planning/management meeting and exchanged opinions with members.

7.2 Review of IEC and ISO Standards

The Railway International Standards Center is now acting as a national reviewing body for the International Electrotechnical Commission (IEC)/TC 9 (Electric facilities and systems of railways) and the International standardization organization (ISO)/TC 17 (Steel)/SC 15 (Rails and auxiliaries).

(1) Response to the Proposal for Organizing a Railway Technical Committee in ISO

France and Germany jointly proposed the

organization of a Railway technical committee (Railway TC) in ISO on November 22, 2011. In reply to the request of the Japan Industrial Standards Committee (JISC), the Railway International Standards Center drafted Japan's answer to the proposal, based on which JISC voted in favour of the proposal. As the votes from different countries satisfied the conditions for instituting the TC, it was formally decided to organize the ISO Railway TC. This followed a poll conducted by correspondence which was arranged by the ISO Technical Management Board (TMB).

While making arrangements to accept the role of a national organization corresponding to the ISO Railway TC, the Railway International Standards Center is now making preparations so that Japan can be in a position to exert leadership in the ISO Railway TC.

(2) Activities of IEC/TC 9

We held the National Committee meetings for IEC/TC 9 in July and October 2011 and in February 2012, to discuss the institution of standards and report the status thereof.

IEC/TC 9 held the 51th General Assembly in Fukuoka, Japan, on November 15 to 18, 2011, with the Railway International Standards Center acting as secretariat (Fig.1). The event was attended by 42 members from 12 countries, including 10 from Japan (inclusive of six from the Railway International Standards Center). The assembly passed 44 resolutions in total, including one to standardize "the procedure to determine the specifications for the train radio system" according to the proposal put forward by Japan. The participants paid a technical visit to the Kumamoto General Rolling Stock Center.

Regarding the discussions on standards, domestic working groups met more than 70 times and seconded about 70 members (from the Railway International Standards Center and other divisions in RTRI) to international conferences.



Fig.1 A scene from the IEC/TC 9 General Assembly in Fukuoka, Japan

(3) Activities of ISO/TC 17/SC 15

We held meetings of the National Committee, ISO/TC 17/SC 15, in August 2011 and February 2012 to discuss and report on correspondence relating to different standards and the proposal for setting up the Railway TC.

Four members from Japan attended the ISO/TC 17/SC 15 committee meeting held in Düsseldorf, Germany, on June 9, 2011.

Furthermore, we seconded 14 members in total from the Railway International Standards Center and other divisions in RTRI to international conferences for discussions on standards.

(4) Activities for ISO Railway Standards

We participated in the national committee and also seconded experts to international conferences to discuss standards for noise measuring methods, synthetic sleepers, fare control systems and other items that are not included in the scope of ISO/TC 17/SC 15.

7.3 Discussions on Strategies for International Standardization in the Field of Railways

To achieve an effective response towards international standardization in the field of railways, we are discussing what strategies to deploy.

(1) Collection of Opinions on Strategies

(a) Liaison meetings between members in different divisions

We have meetings to maintain liaison between members in each of the 10 divisions (rolling stock, car-mounted electrical equipment, parts, power, trolley wires, signals, station facilities, tracks, non-manufacturing matters and JR affairs), in which opinions were exchanged on such issues as the development in Europe and divisional needs to introduce international standards.

(b) Meetings on strategies/planning of international standardization

We held meetings on strategies/planning of international standardization in July 2011 and January 2012 to discuss and report on correspondence relating to the proposal to set up the ISO Railway TC.

(2) Discussions on the Issues Proposed by Japan

Based on the results of the discussions at the Liaison Meetings between Members in Different Divisions and the Meetings on Strategies/Planning of International Standardization, we decided to propose the standardization work on the hybrid system for rolling stock to IEC/TC 9.

(3) Discussions on the Organization of a Railway Technical Committee in ISO

Regarding Japan's proposal to set up a Railway TC in ISO, it was agreed at the first meeting on strategies/planning for international standardization that ISO would have discussions on whether setting up the TC is appropriate or not after analyzing the movement in Europe. ISO repeated the discussion at the following meeting on strategies/planning for international standardization. As France and Germany jointly proposed the establishment of an ISO Railway TC on November 22, 2011, however, it was formally decided, after a vote was taken, to organize the ISO Railway TC.

Responding to this decision, the Railway International Standards Center is making preparations so that Japan can be in a position to exert leadership in the ISO Railway TC.

7.4 Proposals for Domestic Standardization

Regarding the international standards already in force and those expected in the future, we discussed the need to set corresponding domestic standards and supported the work required to incorporate them in Japanese Industrial Standards (JIS).

7.5 Collection, Analysis and Proposals for Information

To collect information on developments concerning the introduction of standards in Europe and related countries in other regions, we implemented the following:

- A survey of the introduction and spread of regenerative brakes in Europe
- A survey of the effect of standardization on railways
- Translation into Japanese of important overseas standards

7.6 Overseas Dissemination of Japanese Railway Technical Information

To make the Japanese railway technical information related to international standardization available, we opened a homepage in English, through which we introduced the status of the discussions on international standards in Japan. We also compiled an English brochure to explain the activities of the Railway International Standards Center to related organizations in overseas countries.

7.7 Promotion of International Standardization Awareness and Training of Human Resources

(1) Seminars

In response to the recent developments in international standardization, we compiled and summarized reference materials and held five seminars for a total of 371 participants to disseminate basic knowledge about international standardization.



Fig.2 A scene from the seminar on international standardization

(2) Secretariat Activities to Honor the Contributors to Standardization Schemes

The Railway Technology Standardization Survey/Discussion Committee sponsored by the Ministry of Land, Infrastructure, Transport and Tourism, Japan, honors those who have contributed to standardization activities. Under the assignment by the said Ministry, the Railway International Standards Center acts as a secretariat for this celebratory event. In FY 2011, four people won an official commendation and two were awarded prizes as encouragement for their contribution to standardization.

A person in the field of railways was also awarded a prize by the Director, Industrial Technology

Environment, at the Ministry of Economy, Trade and Industry, Japan. Furthermore, those people whose work is related to railways in Japan are also highly esteemed in international circles, in that a person was awarded an IECI906 prize by IEC, for example.

7.8 Promotion of Co-operation with Overseas Railway Personnel

(1) Co-operation with Railway-Standards-Related Personnel in Europe

An information exchange meeting was held in September 2011 between JISC-Comité Européen de Normalisation (CEN) and Comité Européen de Normalisation Électrotechnique (CENELEC) in Germany. JISC-CEN Railway Working Group was attended by five members from Europe including the Chairperson, CEN/Railway Expert Committee (TC 256), and eight members from Japan. Active discussions were held in relation to information exchange at the JISC-CENELEC Railway Working Group by eight participants from Europe including the Chairperson, CENELEC/Railway Electric Facilities Expert Committee, and 14 participants from Japan.

(2) Co-operation with Railway-Standards-Related Personnel in Asia

We visited the Ministry of Transport and the Land Transport Agency, Singapore, in July 2011 and KRRI in November 2011 to exchange information, and we decided to continue information exchange with each party approximately once a year.

We held a seminar on international railway standards for the participants in the meeting of ASEAN railway CEO members in conjunction with UIC in October 2011 and another seminar in Malaysia in February 2012. Based on the results of such seminars, we will promote co-operation with railway operators in Asia from now on.

Newly Installed and Remodeled Machines/Facilities

We carried out earthquake-resistant reinforcement work on the lecture hall and on 11 test buildings, applied safety measures to renovate seven laboratories and implemented energy saving work at two worksites and other places.

Regarding test equipment, we completed the installation work of a hybrid loading test machine in March 2012. We also introduced/remodeled 22 test facilities, of which major items are summarized below.

1 Introduction of a Hybrid Loading Test Machine

We introduced a loading test machine to implement hybrid tests for structures. A hybrid test is a new testing method for civil engineering structures to interlink experiments and numerical analyses, in that the behavior

of the whole structure is evaluated using numerical analyses and the behavior of reinforced concrete and other members having non-linear characteristics is evaluated by experiments. By implementing

experiments and analyses simultaneously and interlinking the resultant data, it is now possible to evaluate the large-scale deformation behavior of structures with considerable precision, in particular during major earthquakes. The capacity of the hybrid loading test machine is: a maximum displacement of ± 250 mm under a static load of 750 kN and a maximum displacement of ± 40 mm at frequency 1 Hz under three sine-wave 300 kN loads. To evaluate the safety of railway structures, we developed the machine, placing particular emphasis on its ability to deal with large displacements.

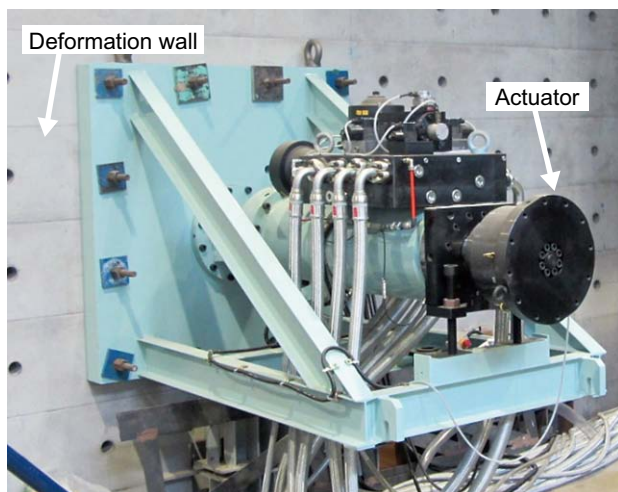

Fig.1 Hybrid loading test machine

2 Installation of a Truck Swinging Performance Test Machine

We use the track swinging performance test machine to measure the truck swinging resistance or the rotational resistance when the truck runs through a curve, which is closely linked with the curve negotiating performance of trucks. This resistance consists of the force to twist the air springs in the longitudinal direction and that generated in the dampers between truck and car-body. It is now possible to measure the resistance

under the train load with air springs, dampers and draw bars incorporated in the truck (under working conditions), whereas we used to measure it indirectly in the past by summing up the results of performance tests of different components, as we were not able to directly measure the resistance on the rolling stock test stand. However, we can now apply the measurement results to the research and development (such as

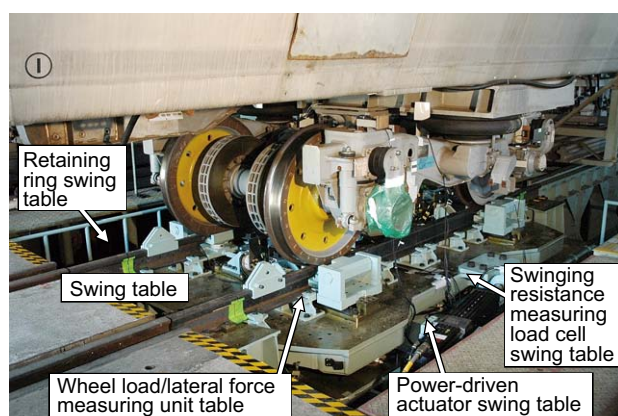

Fig.2 Truck swinging performance test machine

simulation technologies) to improve the sophisticated curve negotiating performance of trucks. To allow use of the machine for inspecting rolling stock for export, we have chosen its specifications on the basis of the standards applied in tests in Europe. The machine also has a function to measure the force exerted between wheel and rail (wheel load and lateral force) at the same time as measuring the swinging resistance.

3 Replacement of a Vibration Testing Device for Components Used by Railways

We replaced a vibration and impact testing device for rolling stock components and other equipment which had been installed in FY 1991. When it was revised in 2008, the JIS E4031 standard on the methods of vibration tests for rolling stock components

adopted random wave excitation in place of the conventional sinusoidal wave excitation. The new testing device exerts a maximum exciting force of 40 kN and allows a maximum load of 500 kg, while featuring two independent excitation directions,

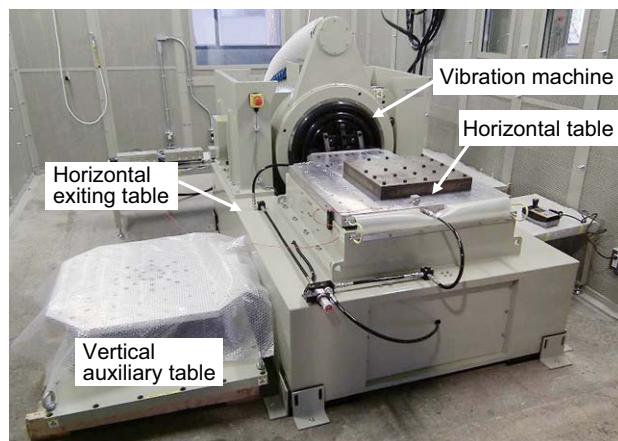

Fig.3 A railway component vibration test machine

vertical and horizontal. It enables random wave excitation in addition to sinusoidal wave excitation to facilitate vibration tests in accordance with the existing JIS standard, which were not possible with the conventional testing equipment. Furthermore, the new testing device enables sinusoidal half-wave pulse impact tests and arbitrary time history waveform excitation, thereby significantly expanding the scope of application and purpose beyond that of the conventional test equipment.

Activities in the 25th Anniversary Year

In the 25th Anniversary Year of RTRI, we held a commemorative symposium “RTRI-25 Years from Now” as an opportunity to consider our management, activities and the direction in which to proceed from now on, with all executive and staff members gathered in a hall.

1 Time and Date

14:00 to 17:15, December 9, 2011 (Fri.)

2 Venue

RTRI Lecture Hall

3 Participants

Executive and staff members, technical advisors (430 persons)

* Relayed to the Maibara Wind Tunnel Test Center through the Internet

4 Program

Three-part composition: (1) RTRI-25 Years in the Past (Lecture 1), (2) Present Activities (Lecture 2) and (3) RTRI-25 Years from Now (Panel Discussion)

Steering person: Hideyuki Takai, Director, Planning Division

Lecture 1: “A 25-Year Challenge to Upgrade Railway Functions”

Lecturer: Hideyuki Takai, Director, Planning Division

Lecture 2: “What shall we do now?”

Lecturer: Norimichi Kumagai, Vice President

Panel Discussion

“RTRI – Our Mission for 25 Years from Now”

Moderator

Hisashi Tarumi, President

Panelists

- Norimichi Kumagai, Vice President
- Takahiro Tomioka, Senior Researcher, Laboratory Head, Vehicle Noise and Vibration, Vehicle Structure Technology Division
- Yoshitaka Murono, Senior Researcher, Laboratory Head, Earthquake and Structural Engineering, Structures Technology Division
- Shigeto Hiraguri, Senior Researcher, Laboratory Head, Train Control Systems, Signalling and Telecommunications Division
- Masaru Tomita, Senior Researcher, Laboratory Head, Applied Superconductivity, Materials Technology Division
- Yumeko Miyachi, Senior Researcher, Laboratory Head, Safety Analysis, Human Science Division

5 Summary of Programs

In Lecture 1, Director Takai, Planning Division, reflected on the development of RTRI in the past 25 years, outlining the activities of RTRI since its inception while using pictures and drawings, introducing improved test facilities to support its activities and to maintain technological potential, and setting up new organizations to cope with the expanded scope of activities.

In Lecture 2, Vice President Kumagai summarized the subjects and directions to follow in order to enhance the presence of RTRI based on the present situation of railway industries. He emphasized the importance of bearing in mind the "RTRI Research Map," a plan for research and development that was summarized in 2009 envisaging RTRI's image for the next 25 years and requiring each employee to act positively while recognizing the social role of RTRI.

To consider the next 25 years for RTRI, we set two themes in the panel discussions based on Lectures 1 and 2, "the future image of management and operation – what research management shall be" and "future image of research and development – research to achieve breakthroughs."

At the beginning, President Tarumi, Moderator, raised two topics: "Changes in the social and transport

environments" and "The current subjects for RTRI." Then, young panelists or five laboratory heads presented their opinions on such issues as "how research themes should be evaluated," "the relationship between government and railway operators," "keeping and training of human resources," "importance of basic research," "viability of simulation in research" and "the necessity of summarizing accident data."

After questions from the audience were answered, active information exchanges took place between the panelists and participants on such themes as "training the successors of Heads of Laboratory," "keeping human resources" and "how to invest in test facilities."

To conclude the seminar, the moderator stated, "Twenty-five years have passed since RTRI was inaugurated. In the meantime, we have constantly sought to make progress. Now, we have a group of resolute researchers on board. For the coming 25 years, we shall continue to challenge innovative research and development, to discuss test facilities based on a new concept, to show integrated technologies supported by our experience and accumulated knowledge, to maintain close links with railway operators and to proceed further under a banner which reads: keep to the fundamentals."



Fig.1 Lecture 1 (left) and Lecture 2 (right)



Fig.2 Panel Discussion

Appendix

1 Publications

(1) RTRI Report

Vol. No.	Titles
Vol. 25 No. 4 (Apr. 2011)	<p>Special Features: Power Supply Technology</p> <p>REVIEW: Recent State of Researches on Power Supply Technology for Electric Railways</p> <p>PAPERS: Earth-fault Detection of Feeder Cables for D.C. Traction</p> <p>PAPERS: Fault Current Analysis Considering Frequency Response of Feeding Circuits</p> <p>PAPERS: Installation Guidelines of Overhead Contact Line for Shinkansen High-speed Operation</p> <p>PAPERS: Measures for Running of Train with One Pantograph in Copper Rigid Conductor Equipment</p> <p>PAPERS: Unevenness of Sliding Surface of Overhead Rigid Conductor Line and its Reduction Method</p> <p>PAPERS: Detecting Method of Step-shaped Wear on Contact Strip by Measurement of Contact Wire Vibration</p> <p>PAPERS: Development of the Hanger-ear against Heavily Corrosive Environment</p> <p>RESEARCH REPORT: Trend Investigation of Image Technology Application to Contact Line Inspection and Condition Monitoring</p>
Vol. 25 No. 5 (May 2011)	<p>Special Features: Signalling and Telecommunications Technology</p> <p>REVIEW: Trends of Radio Based Train Control Systems</p> <p>PAPERS: Train Control System for Secondary Lines using Radio Communications in Specific Area</p> <p>PAPERS: Development of Train Control System by Using Information of Train Position with Wireless IC-tag</p> <p>PAPERS: Development of the Track Circuit with Excellent Noise Immunity Performance</p> <p>PAPERS: Monitoring Method for a Switching Load of Spring Point Machines</p> <p>PAPERS: Development of a System to Make up an Interlocking Circuit Diagram Automatically from an Interlocking Table</p> <p>PAPERS: Development of a Lightning Surge Calculation Model on Railway Level Crossing</p> <p>PAPERS: A Visibility Check Method for Obstruction Warning Signal</p> <p>PAPERS: Development of a Simulation Software to Calculate Fluctuations of Strength of Radio Disturbance Wave Emitted from Railway Systems to Railway Side</p>
Vol. 25 No. 6 (Jun. 2011)	<p>Special Features: Railway Dynamics</p> <p>REVIEW: Recent Research and Development in Railway Dynamics</p> <p>PAPERS: Control of Contact force between Pantograph and Catenary Using Impedance Control Technique</p> <p>PAPERS: Direction and Velocity Characteristics of Air Flow around Pantograph of Running Train</p> <p>PAPERS: Development of Lateral Damper for Improvement of Running Safety of Railway Vehicles in Case of Occurrence of an Earthquake</p> <p>PAPERS: Characteristics of Secondary Suspension of Vehicle under Large Displacement Condition</p> <p>PAPERS: An Effective Application Method of Friction Moderator to Low Rail of Curve</p> <p>PAPERS: A Estimation Method for Equivalent Natural Period with Microtremor Measurement</p> <p>PAPERS: Numerical Study on Performance Evaluation of Vehicle Guide Device</p> <p>PAPERS: Dynamic Behavior of Ballasted Track at Earthquake</p>
Vol. 25 No. 7 (Jul. 2011)	<p>Special Features: Disaster Prevention Technology</p> <p>REVIEW: Characteristics of the Recent Disaster Corresponding to Change of Nature and the Prospects of Future Research and Development</p> <p>PAPERS: Improvement of Earthquake-parameter Estimation for Earthquake Early Warning</p> <p>PAPERS: Calculation Technique to Reduce Drift Component in Integrating Ground Displacement from Seismic Acceleration Records</p> <p>PAPERS: A Method for Precaution against Avalanches Based on Stability Indices of the Slope Snow Cover</p> <p>PAPERS: Health-monitoring System for Bridge Pier Foundation by Micro-tremor Measurement</p> <p>PAPERS: Evaluation Methods of Rock Lump Stability on Rock Slopes</p> <p>PAPERS: A Method of Determining Priorities for Investment in Disaster Prevention for Rockfalls from Slopes</p> <p>PAPERS: Evaluation of Influence of Anemometer Position around Railway Structures on Observation Data of Wind</p>
Vol. 25 No. 8 (Aug. 2011)	<p>Special Features: Vehicle Technology</p> <p>REVIEW: Recent Topics on Railway Vehicle Technology</p> <p>PAPERS: Suppression of Low-frequency Lateral Vibration by Improving the Response of Pneumatic Actuator for Tilt Control</p> <p>PAPERS: Parameter Updating of an Analytical Model for Three-Dimensional Flexural Vibrations of Carbody by Using Measured Data</p> <p>PAPERS: A Method of Sound Monitoring for Railway Vehicles with Acceleration on a Bogie</p> <p>PAPERS: Evaluation of Carbody Strength against Loads from the Side</p> <p>PAPERS: Alteration of Turned Wheel's Surface Condition and Effectiveness of Lubrication against Flange Climb Derailment</p> <p>PAPERS: Study of Heat Radiation Materials Using High Thermal Conductivity Organic Fiber for Electronic Components and Power Devices</p> <p>PAPERS: A Simplified Calculation Method of Energy Consumption for Railway Vehicles</p> <p>PAPERS: Development of the Estimating Method of Low-frequency Return-current of DC Electric Railcar</p>
Vol. 25 No. 9 (Sep. 2011)	<p>Special Features: Seismic Design Technology for Railway Structures</p> <p>REVIEW: Trend of Recent Techniques Regarding Seismic Design of Railway Structures</p> <p>PAPERS: Evaluation of the Level 2 Earthquake Motion by Using Recent Records</p> <p>PAPERS: Evaluation of Nonlinear Dynamic Response at Subsurface Ground Applying GHE-S Model</p> <p>PAPERS: Angular Rotation Assessment Method for Track Using Seismic Wavelength Originated from Surface Waves</p> <p>PAPERS: The Verification Method of Restorability of Reinforced Concrete Structures by Using the Total Cost Index</p> <p>PAPERS: Seismic Design of Retaining Wall and Bridge Abutment Considering the Dynamic Response Characteristic</p> <p>PAPERS: Evaluation of Failure Mode of Cut and Cover Tunnels in Consideration of Non-linearity of Ground</p> <p>PAPERS: Simple Method to Evaluate the Residual Uplift Displacement of Open Cut Tunnel Caused by Liquefaction</p> <p>PAPERS: Effect of Inertial and Kinematic Interaction on Seismic Behavior of Various Types of Structures</p>

Vol. No.	Titles
Vol. 25 No. 10 (Oct. 2011)	<p>Special Features: Materials Technology</p> <p>REVIEW: Recent Trend of Research and Development on Materials for Railway Facilities</p> <p>PAPERS: Development of an Alkali-Silica-Reaction Suppressing Material with Li-containing Zeolite</p> <p>PAPERS: Development of a Compact Permanent Magnet System Based on High T_c Superconductors</p> <p>PAPERS: New Grease Replacement System for Midterm Lubrication for Traction Motor Bearings</p> <p>PAPERS: Mechanism and Countermeasure of Wheel Tread Thermal Cracking</p> <p>PAPERS: Evaluation of Life Cycle CO₂ Emissions by Various Types of the Meter Gauged Railway Vehicle</p> <p>PAPERS: Evaluation of Workability on Flame Resisting Magnesium Alloy</p> <p>PAPERS: Improvement in Performance of Piezoelectric-rubber Using Particles Orientation</p> <p>PAPERS: Ion-exchange Properties of Hardened Geopolymer Paste</p>
Vol. 25 No. 11 (Nov. 2011)	<p>Special Features: Environmental Technology</p> <p>REVIEW: Current Status of Research and Development on Railway Aerodynamics</p> <p>PAPERS: Quantitative Estimation of the Influence of Surrounding Buildings on Wayside Railway-noise Level</p> <p>PAPERS: Noise Reduction Effect of Low Barriers Installed Close to Rail</p> <p>PAPERS: An Investigation on Vibratory and Acoustical Characteristics of Concrete Bridge for Shinkansen</p> <p>PAPERS: Analysis of Mechanism of Wind Load Reduction of the Developed Soundproof System</p> <p>PAPERS: Experimental Method in Wind Tunnel Tests to Simulate the Turbulent Flow on the Roof of High-speed Trains</p> <p>PAPERS: Propagation Characteristics of Horizontal and Vertical Component of Train-induced Ground Vibration</p> <p>PAPERS: Evaluation of Mutagenic Effect of Complex Magnetic Fields with Static and Time-varying Magnetic Fields</p> <p>PAPERS: A Simulation Method on Airflow and Temperature in Long Railway Tunnel with Ventilation Fans</p>
Vol. 25 No. 12 (Dec. 2011)	<p>Special Features: Transport Information Technology</p> <p>REVIEW: Application of Mathematical Optimization Technologies to Railways - Recent Trends and Future Prospects -</p> <p>PAPERS: A Practical Train Rescheduling Algorithm Applying Predetermined Factors</p> <p>PAPERS: A Psychological Model of Passengers' Dissatisfaction for Evaluating Train-rescheduling Plans on Metropolitan Rail Lines</p> <p>PAPERS: Rolling Stock Rescheduling Algorithm for Passenger Trains during Disruption of Train Operation</p> <p>PAPERS: Providing Train Information on forecast and Consequential Decision Making for Train-choice</p> <p>PAPERS: Development of Low-cost Fare Collection System Suitable for Medium-scale City Areas</p> <p>PAPERS: Development of an Estimation Method of Modal Share Considering Passengers' Latent Preference for Transportation Modes</p> <p>PAPERS: Availability Evaluation of Sensor Networks for the Railway Facilities Condition Monitoring</p> <p>RESEARCH REPORT: Technical Issues to be Faced with Identified from the Management Analysis of Local Railway Companies</p>
Vol. 26 No. 1 (Jan. 2012)	<p>Special Features: Human Science</p> <p>REVIEW: Recent Topics on Human Scientific Approach to Railway Transport Research</p> <p>PAPERS: Occurrence Factors of Sleepiness of Freight Train Drivers</p> <p>PAPERS: Experience-Based PC Learning System for Human Error Prevention by Point and Call Check</p> <p>PAPERS: Method to Support Risk Management of Human Error in the Traffic Dispatchers</p> <p>PAPERS: Simulation of Behavior of Passengers aboard Commuter Train in the Event of Level Crossing Accident</p> <p>PAPERS: Promoting the Consciousness of Railway Employees about Keeping Rules for Making Passenger Announcements</p> <p>PAPERS: Method of Evaluating Ride Comfort Reflecting Passengers' Subjective Sensation to High Frequency Vibration</p> <p>PAPERS: Analysis of Odorous Chemicals Collected in the Air of Railway Facilities</p> <p>RESEARCH REPORT: Social Cognitive Contents for Risk Management</p>
Vol. 26 No. 2 (Feb. 2012)	<p>Special Features: Track Technology</p> <p>REVIEW: The History of Track Structure Design and the Future</p> <p>PAPERS: Development of the Body-mounted Track Measuring Device with the Inertial Mid-chord Offset Method</p> <p>PAPERS: Optimal Track Maintenance Strategy Model Constructed by Considering Deterioration Level of both Rail and Ballast</p> <p>PAPERS: Development of Pre-packed Concrete Trackbed for Shinkansen</p> <p>PAPERS: Study of the Effect of Track Irregularity Prevention Methods for the Transition Zone between Different Track Structures</p> <p>PAPERS: Experimental Study on the Prediction Method of Transverse Crack Growth Rate in Rail Head</p> <p>PAPERS: Laying Standards of Wire Spring Clip Fastening System in the Curved Section</p> <p>PAPERS: Selection of An Effective Surface Treatment Method of Wire Spring Clips in the Severe Corrosion Environment</p> <p>OTHER PAPER: Influential Factors on Adhesion between Wheel and Rail under Wet Conditions</p>
Vol. 26 No. 3 (Mar. 2012)	<p>Special Features: Vehicle Technology</p> <p>REVIEW: Leading-edge of Technology of Rail-vehicles Expected for Practical Use</p> <p>PAPERS: Fundamental Tests of Rapid Prototyping Bogie</p> <p>PAPERS: Performance Tests of Assist Steering System for Bolsterless Truck</p> <p>PAPERS: An Application of Assist Steering System for Bogie Angle Linked Steering Truck</p> <p>PAPERS: Pneumatically Operated Floating Brake Calliper for Shinkansen Vehicles</p> <p>PAPERS: Load Estimation Method of Truck Frame by Measuring Acceleration</p> <p>PAPERS: Numerical Analysis of Improvement of Curving Performance of a Vehicle by Providing Wheel Tread Profile with Fine Unevenness</p> <p>PAPERS: Study on Noise Radiated from Gear Case of Parallel Cardan Driving Device</p> <p>PAPERS: Reduction of Reactor Weight by Using Electromagnetic Coupling</p>

(2) Quarterly Report (QR)

Vol. No.	Titles
Vol.52 No.2 (May 2011)	<p>PAPERS: Broadband Telecommunication System for Railways Using Laser Technology</p> <p>PAPERS: Approach for Evaluating the Effectiveness of Rail Freight Transport in Reducing Logistics Costs and Carbon Dioxide(CO₂) Emissions</p> <p>PAPERS: Freight Locomotive Rescheduling Algorithm under Disordered Train Operation</p> <p>PAPERS: Application of Nanocomposites to Floor Sheet for Railway Vehicle</p> <p>PAPERS: Evaluation of the Durability of Cement-based Repair Materials</p> <p>PAPERS: Influence of Type of Grinding Stone on Rail Grinding Efficiency</p> <p>PAPERS: Investigation of Radiation Characteristics of Noise from Rail</p> <p>PAPERS: A Method for Prediction of Structure-borne Noise Radiated from Concrete Railway Viaducts</p> <p>PAPERS: Theoretical Model for Micro-pressure Wave Emission Considering the Effect of Topography around the Tunnel Portal</p>
Vol.52 No.3 (Aug. 2011)	<p>PAPERS: Numerical Analysis of Wheel/Rail Contact Characteristics Based on Actual Wheel Profiles</p> <p>PAPERS: Development of a New Wheel Slide Protection System Using a New Detection Algorithm</p> <p>PAPERS: Development of Displacement-Dependent Rubber Bush to Reduce Carbody Vibration Induced by Mass-Imbalanced Wheelsets through Traction Links</p> <p>PAPERS: Evaluation of Factors Contributing to Deterioration of Track-slab in Cold Areas</p> <p>PAPERS: Assessment of Aseismic Performance of Ballasted Track with Large-scale Shaking Table Tests</p> <p>PAPERS: Development of a Model for Analyzing the Propagation of Transverse Cracking of Rail</p> <p>PAPERS: Method to Support Risk Management of Human Error in Track Maintenance Work</p> <p>PAPERS: New Commuter Train Driver Desk Design Proposal Suited to a Wider Range of Body Sizes</p> <p>REVIEW: Application of Human Simulation Technology in Railway Systems</p>
Vol.52 No.4 (Nov. 2011)	<p>REVIEWS: Outline of the "2011 off the Pacific Coast of Tohoku Earthquake" and Related Activities of RTRI</p> <p>REVIEWS: Characteristics of the Recent Disasters Corresponding to the Changing Natural Environment and the Prospects of Future Research and Development</p> <p>PAPERS: Improvement of Seismic Parameter Estimation for the Earthquake Early Warning System</p> <p>PAPERS: Guidelines for Selection of Appropriate Seismic Countermeasures for Existing Mountain Tunnels in Poor Geological Conditions</p> <p>PAPERS: Seismic Retrofitting Effects of Reinforcing Over-track Building with Knee-brace Dampers</p> <p>PAPERS: Evaluation for Flexural-load Capacity of Prestressed Concrete Girders with Broken Tendons</p> <p>PAPERS: Installation Guidelines for Shinkansen High Speed Overhead Contact Lines</p> <p>PAPERS: Method for Detecting Step-shaped Wear on Contact Strips by Measuring Catenary Vibration</p> <p>PAPERS: Fault Current Analysis Considering Frequency Response of Feeding Circuits</p>
Vol.53 No.1 (Feb. 2012)	<p>PAPERS: Train Control System for Secondary Lines Using Radio Communications in Specific Area</p> <p>PAPERS: Development of a Lightning Surge Calculation Model for Level Crossing Signalling Equipment</p> <p>PAPERS: Development of a Simulation Software to Calculate Fluctuations in Strength of Radio Frequency Noise Emitted from Electric Railway Systems into the Trackside Environment</p> <p>PAPERS: Method to Estimate Equivalent Natural Period with Micro-tremor Measurements</p> <p>PAPERS: Advanced Active Control of Contact Force between Pantograph and Catenary for High-Speed Trains</p> <p>PAPERS: Development of a Lateral Damper to Improve the Running Safety of Railway Vehicles during an Earthquake</p> <p>PAPERS: Performance of Linear Motor Type Rail Brake Using Roller Rig Test Bench</p> <p>PAPERS: Development of the On-board Maintenance Management System for Ground Coils of Maglev by Using RFID Technology</p> <p>PAPERS: Examination of Vehicle Motion Characteristics of a Maglev Train Set Using a Reduced-scale Model Experiment Apparatus</p>

(3) Newsletter, "Railway Technology Avalanche"

No.	Titles
No.35 (Jun. 2011)	<ul style="list-style-type: none"> • "Incredible" and "Inevitable" Events • Great East Japan Earthquake Disaster • Development of the Prestressed Ballast Track • Evaluation of the Stability of Rocks on Slopes in Consideration of Weathering • Development of a Low-Frequency Track Circuit with Improved Noise-Resistant Features • Development of a Train Operation/Passenger Behaviour Simulation System
No.36 (Sep. 2011)	<ul style="list-style-type: none"> • RTRI's International Activities • WCRR 2011: World Congress on Railway Research 2011 Successfully Completed • Measurement of Velocity and Pressure Fluctuations around High-speed Trains Running in Tunnel • Development of a Mobile Broadband Telecommunications System for Railways Using Laser Technology • Prediction of Contact Wire Wear on High-speed Railways • Influential Factors on Adhesion between Wheel and Rail under Wet Conditions • Indoor Air Quality at Stations: Development of a Methodology for Quantifying Railway Customers' Perception of Odor at Stations • Improving the Running Safety of Railway Vehicles against an Earthquake • Practical Use of the Earthquake Early Warning (EEW) System for the Shinkansen • Identification of Thermal Cracking Criteria on Wheel Treads for Optimized Brake System Design
No.37 (Dec. 2011)	<ul style="list-style-type: none"> • RTRI's Promotion of Research and Development in Recent Years • The 11th China-Korea-Japan Railway Research Technical Meeting • A Method to Measure the Contact Force of Pantographs through Image Processing • Wind Tunnel Test on Windbreak Fence Installed on Railway Lines • A Ride Comfort Evaluation Method to Reflect the Effect of High-Frequency Vibration • A Study of Non-Contact Power Supply Systems
No.38 (Mar. 2012)	<ul style="list-style-type: none"> • Research and Development for Sustainable Evolution of Railways • Activities of the Railway International Standards Center • A Tilt Control System Focused on Preventing Motion Sickness • A Simplified Method to Calculate the Energy Consumed by Rolling Stock • Listening Difficulty Tests on Broadcast Announcements for Passengers at Stations • Development of Surge Detection Type Fault Locating System for AC Feeding Circuits

2 Lectures

(1) RTRI Lecture

Special addresses	Damage by chaotic tsunamis and technologies to minimize disasters
Keynote address	Railway technologies to prepare for large-scale natural disasters
General address	<ul style="list-style-type: none"> • Special features of the Tohoku Region Pacific Coast Earthquake and precautionary earthquake detection • Earthquake resistance technologies for ground facilities • Improvement of running safety at earthquakes • Protection of trains from strong winds • Preparation for heavy rainfalls

(2) Monthly Presentation

Theme	Date
Recent research and development on disaster prevention technologies	April 22, 2011
Recent research and development on facilities materials	May 20, 2011
Recent research and development on power technologies	June 15, 2011
Recent research and development on transport technologies	July 13, 2011
Recent research and development on rolling stock technologies	August 26, 2011
Recent research and development on track technologies	September 28, 2011
Recent research and development on human sciences	October 28, 2011
Recent research and development on structure technologies	December 21, 2011
Recent research and development on environmental engineering	January 18, 2012
Recent research and development on the levitated railway and application of its technologies	February 15, 2012
Recent research and development on signal and telecommunication technologies	March 14, 2012

3 Statistics

(1) Record of Recognition

Title	Name of awardee	Category of prize	Date of reward
Commendation by Minister of Education, Culture, Sports, Science and Technology, Japan	Shun-ichi Kubo Hiroshi Tsuchiya	Evaluation of wear characteristics of pantograph carbon-base contact strips	April 11, 2011

Commending organization	Category of prize
Academic societies	• Japan Society of Mechanical Engineers, Encouragement Award
	• Japan Society of Civil Engineers - Award for Research Paper, Structural Engineering Symposium - Research Paper Encouragement Award - Award for Technical Development
	• The Japanese Geotechnical Society, Young Researcher Award for Excellent Research Paper Contributed to an International Conference
	• Japan Society of Civil Engineers, Structural Engineering Committee Research Paper Encouragement Award
	• The Visualization Society of Japan, Award of the Society (Encouragement Award)
	• Japan Society of Civil Engineers, Encouragement Award for Applied Dynamics Research Paper
	• The Institute of Electrical Engineers of Japan, Award for Research Paper in the Industrial Application Division
	• Japan Society of Applied Electromagnetics and Mechanics, Encouragement Award
Associations	• The Society for Risk Analysis of Japan, Award for Research Paper
	• The Japan Railway Civil Engineering Association, Award for Research Paper
	• World Congress on Railway Research (WCRR), Award for Research Paper
	• The Japan Railway Electrical Engineering Association, Award of Technology
	• The Society of Rubber Science and Technology, Japan, Young Researcher Encouragement Award
	• Congress of Japan Railway Cybernetics, Award for Outstanding Research Paper
	• Japan Institute of Invention and Innovation, Award for Invention
	• Railway Engineering, Award for Research Paper
	• Japan Institute of Construction Engineering, Award for Development of Construction Engineering
	• The Japan Electric Association, Shibusawa Award
• Japan Train Operation Association, Award of President	

Commending organization	Category of prize
RTRI	Reward for Outstanding Research and Development <ul style="list-style-type: none"> • Development of an air pressure actuator to control the high-performance tilting mechanism • Development of a method to measure pantograph contact force based on image processing • Improvement of ride comfort filters to cope with high-frequency vibration
	Reward for Outstanding Service Achievement <ul style="list-style-type: none"> • A survey on the damage of gears • Cooperation to a survey on derailment at earthquakes by the Taiwan High-Speed Railway
	Prize for Outstanding Research and Development <ul style="list-style-type: none"> • A high-precision technique to determine the elastic natural period of railway viaducts and a method to convert into an equivalent natural period. • Development of a base-point radio control system for light traffic lines • Analysis of the three-dimensional motion and measures to improve the durability of contact wires • Research on the measures against earthquakes for mountain tunnels • A technique to simulate the behavior of passengers at train collision.
	Prize for Outstanding Service Achievement <ul style="list-style-type: none"> • Introduction of short-time services • A proposal of vibration-proof measures for city areas over Shinkansen tunnels • A technical guidance for the method to observe winds and restrict train operation in strong winds • Institution of standards on the design of railway structures (track structures)
	Prize for Encouragement of Research and Development <ul style="list-style-type: none"> • Development of an experimental evaluation technique for aerodynamic noise sources by the particle image flow measuring method • Development of a technique to analyze large-scale deformation and flow of the ground by the particle method
	Prize for Meritorious Service <ul style="list-style-type: none"> • Smooth reorganization into a public interest incorporated foundation • Opening of the 10th International Workshop on Railway Noise

(2) Patents in Possession

Regarding the patents applied for, we do not claim examination of those with little operability or for which improvements have been applied for registration.

We also scrutinized the patents in possession with respect to the necessity of holding or possibility of abandonment. We positively disclaimed the patents for which 10 years or over have passed after registration and little operability is expected.

As of FY 2011, the results of the scrutiny are as follows.

Newly registered patents, etc.

Patents, 215; Design patents, 0; Total, 215

Patents of which the rights has expired

Patents, 13

Abandoned patents, etc.

Patents, 119; Design patents, 2; Total, 121

Consequently, we have 2,220 registered industrial property rights (including 19 trademarks).

Table 1 Domestic industrial rights in possession (As of March 31, 2012)

Category		Independently owned	Jointly owned	Subtotal
Patent	Registered	615	469	1,084
	Applied for (Examination applied for)	702 (332)	388 (204)	1,090 (536)
	Subtotal	1,317	857	2,174
Utility model	Registered	0	0	0
	Applied for	0	0	0
	Subtotal	0	0	0
Design patent	Registered	12	13	25
	Applied for	0	2	2
	Subtotal	12	15	27
Trademark	Registered	19	0	19
	Applied for	0	0	0
	Subtotal	19	0	19
Total	Registered	646	482	1,128
	Applied for	702	390	1,092
	Grand total	1,348	872	2,220

Table 2 Overseas industrial rights in possession (As of March 31, 2012)

Status	Number of applications	Number of the countries of registration
Registered	34	83
Registered or applied for	Registered	25
	Applied for	-
Applied for	8	-
Total	50	108

4 Press Release

April 1, 2011	Rebirth of the Railway Technical Research Institute (RTRI), from a juridical foundation into a public interest incorporated foundation
April 1, 2011	New executive members, Railway Technical Research Institute (Public Interest Incorporated Foundation)
April 4, 2011	FY 2011 Initiation Ceremony
May 16, 2011	Receiving Commendation by Minister of Education, Culture, Sports, Science and Technology, Japan
June 6, 2011	Conclusion of an agreement to promote the research of power storage technology
June 9, 2011	Opening of WCRR2011
June 22, 2011	Receiving the commendation for nationwide outstanding inventions in FY 2011
June 29, 2011	Opening of "a structural technologies (designing, analysis) exchanging meeting"
July 1, 2011	New executive members, Railway Technical Research Institute (a public interest incorporated foundation)
July 26, 2011	Opening of "an environmental technologies exchange meeting"
September 22, 2011	Activities by the Recovery Operation Center for the railways damaged by the Tohoku Region Pacific Coast Earthquake and installation of a technology discussing committee
September 26, 2011	Opening of "a rolling stock technology exchange meeting"
October 11, 2011	Opening of "RTRI Kansai Area technology exchange meeting 2011"
October 19, 2011	Opening of "a training/nurturing of railway structure diagnosis experts"
November 25, 2011	Opening of "a signal and telecommunication technology exchange meeting"
November 28, 2011	Opening of "the IEC/TC Annual General Assembly"
November 30, 2011	Opening of "a power technology exchange meeting"
December 14, 2011	The FY 2011 ceremony of the anniversary of the foundation
December 16, 2011	A technological proposal to recover/restore railways damaged by earthquake disasters

(FY 2011: April 1, 2011 - March 31, 2012)

Copyright© 2012 by Railway Technical Research Institute. All rights reserved.

Published by Atsushi Ichikawa, Executive Director

Corresponding:

International Affairs Division, Railway Technical Research Institute
Hikari-cho 2-8-38, Kokubunji-shi, Tokyo 185-8540, Japan
URL: <http://www.rtri.or.jp/>

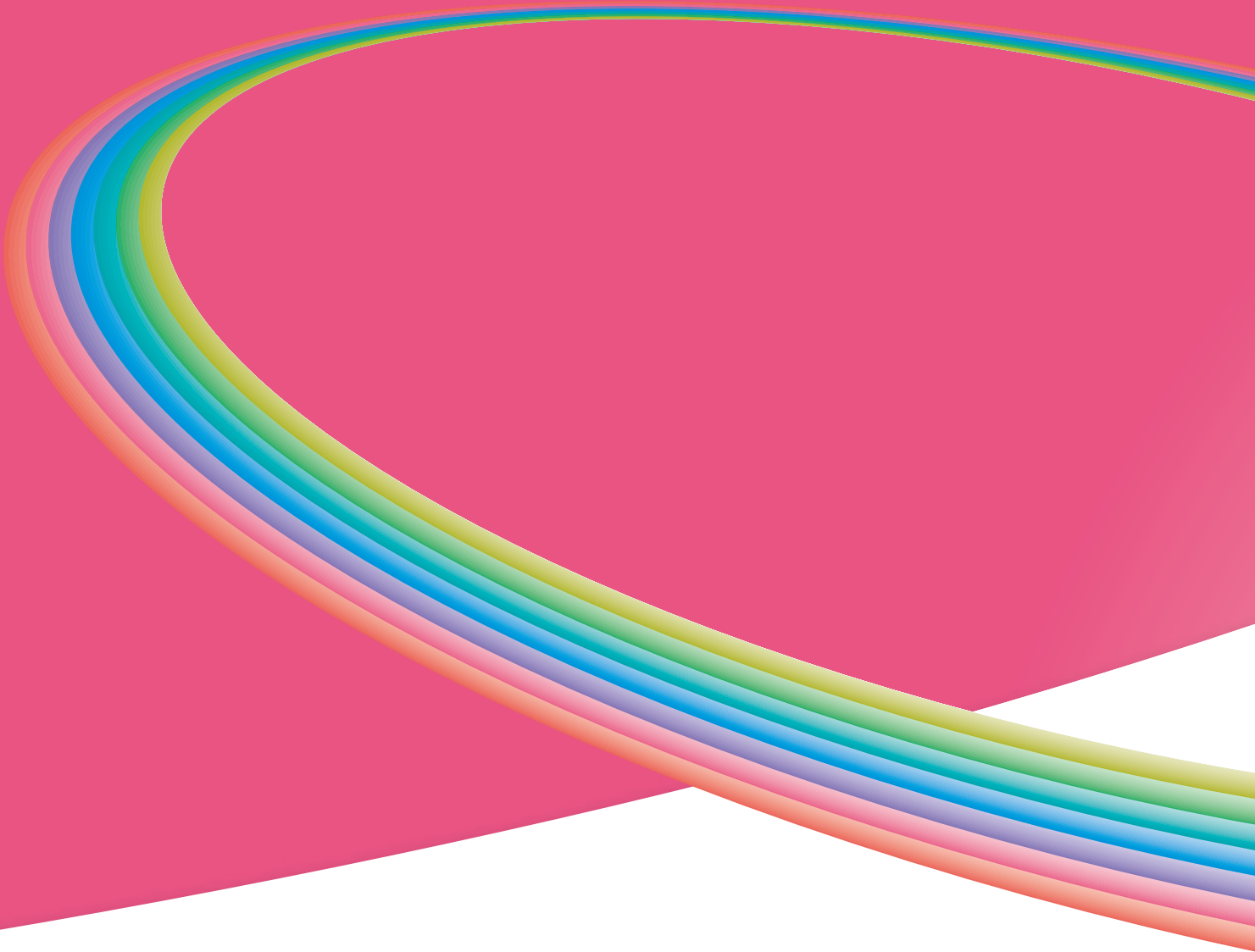

Railway Technical Research Institute

Hikari-cho 2-8-38, Kokubunji-shi, Tokyo 185-8540, Japan
<http://www.rtri.or.jp/>